

800MHz/900MHz FM TRANSCEIVER

TK-980/981

SERVICE MANUAL

SUPPLEMENT III

KENWOOD

Kenwood Corporation

© 2011-3 PRINTED IN JAPAN
B51-8968-00 (Y) PDF

This service manual applied product with 00400985 (TK-980(K)), 00500201 (TK-980(M)), B1300164 (TK-981) or subsequent serial numbers.

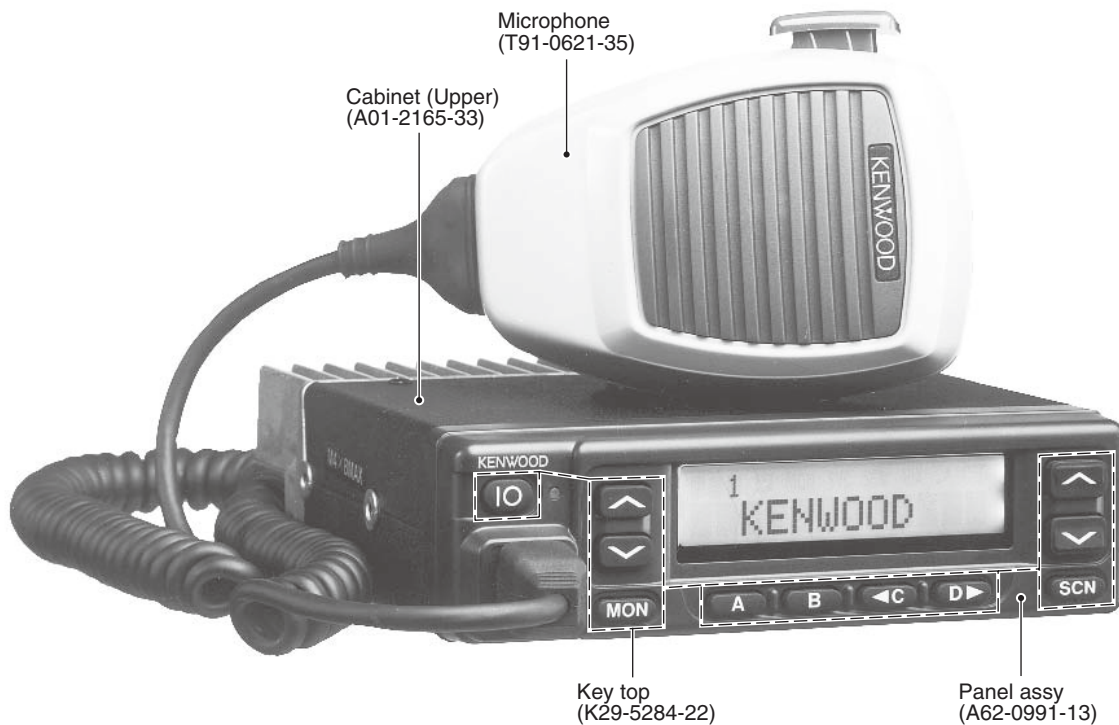

CONTENTS

DISASSEMBLY FOR REPAIR	2	
PARTS LIST	3	
PC BOARD		
PLL/VCO UNIT (X58-4530-XX)	9	
		TX-RX UNIT (X57-6520-XX) (A/2)
		TX-RX UNIT (X57-6520-XX) (B/2)
		SCHMATIC DIAGRAM



TK-980/981

Document Copyrights

Copyright 2011 by Kenwood Corporation. All rights reserved.

No part of this manual may be reproduced, translated, distributed, or transmitted in any form or by any means, electronic, mechanical, photocopying, recording, or otherwise, for any purpose without the prior written permission of Kenwood.

Disclaimer

While every precaution has been taken in the preparation of this manual, Kenwood assumes no responsibility for errors or omissions. Neither is any liability assumed for damages resulting from the use of the information contained herein. Kenwood reserves the right to make changes to any products herein at any time for improvement purposes.

DISASSEMBLY FOR REPAIR

Compatibility information

The PLL IC (IC300:SA7025DK) has been discontinued by the supplier, so New PLL IC(IC450:LMX2352TMX/NP) has been applied on to X57-6520-XX production.

TK-980 K,M / TK-981 K (TX-RX Unit : X57-6520-XX)				
Ref.	Part Name	OLD Part	NEW Part	Compatibility
		TK-980(K) : S/No. 00400984 and before TK-980(M) : S/No. 00400518 and before TK-981(K) : S/No. B1300163 and before	TK-980(K) : S/No. 00400985 ~ TK-980(M) : S/No. 00500201 ~ TK-981(K) : S/No. B1300164 ~	
IC300(OLD)	PLL IC	SA7025DK	—	No
IC450(NEW)		—	LMX2352TMX/NP	
—	PC board (X57-6520-XX)	J72-0816-x9	J79-0294-x9	No

PARTS LIST

*New Parts. Δ indicates safety critical components.

Parts without **Parts No.** are not supplied.

Les articles non mentionnes dans le **Parts No.** ne sont pas fournis.

Teile ohne **Parts No.** werden nicht geliefert.

L : Scandinavia

Y : PX (Far East, Hawaii)

C : China

K : USA

T : England

X : Australia

P : Canada

E : Europe

M : Other Areas

TX-RX UNIT (X57-6520-XX)

Ref. No.	Address	New parts	Parts No.	Description	Desti-nation	Ref. No.	Address	New parts	Parts No.	Description	Desti-nation
TX-RX UNIT (X57-6520-XX) 0-10 : TK-980 0-11 : TK-981											
D511			B30-2151-05	LED(RED/GREEN)		C77			CE32BD1E470M	CHIP EL 47UF 25WV	
D512-517			B30-2171-05	LED		C78			CK73GB1E103K	CHIP C 0.010UF K	
C1 -15			CC73GCH1H101J	CHIP C 100PF J		C79		*	CE32BD1C471M	CHIP EL 470UF 16WV	
C16			CS77BA1A100M	CHIP TNTL 10UF 10WV		C80			K73GB1C104K	CHIP C 0.10UF K	
C18			CS77BA0J4R7M	CHIP TNTL 4.7UF 6.3WV		C83			CK73FB1H473K	CHIP C 0.047UF K	
C19			CC73GCH1H100D	CHIP C 10PF D		C84			CC73GCH1H120J	CHIP C 12PF J	TK-980
C20 -22			CC73GCH1H101J	CHIP C 100PF J		C84			CC73GCH1H220J	CHIP C 22PF J	TK-981
C23			CS77BA0J4R7M	CHIP TNTL 4.7UF 6.3WV		C85			CK73GB1H102K	CHIP C 1000PF K	
C24			CC73GCH1H101J	CHIP C 100PF J		C87			CC73GCH1H101J	CHIP C 100PF J	
C25			CS77BA0J4R7M	CHIP TNTL 4.7UF 6.3WV		C88			CK73GB1E103K	CHIP C 0.010UF K	
C27			CK73GB1H102K	CHIP C 1000PF K		C89			CK73GB1H471K	CHIP C 470PF K	
C28			CC73GCH1H220J	CHIP C 22PF J		C90			CK73GB1H102K	CHIP C 1000PF K	
C29			CS77BA1A100M	CHIP TNTL 10UF 10WV		C91 ,92			CK73GB1E103K	CHIP C 0.010UF K	
C30			CK73GB1H102K	CHIP C 1000PF K		C94			CK73GB1H471K	CHIP C 470PF K	
C31			CS77BA1A100M	CHIP TNTL 10UF 10WV		C96			CC73GCH1H180J	CHIP C 18PF J	
C32			CC73GCH1H100D	CHIP C 10PF D		C97			CK73GB1H102K	CHIP C 1000PF K	
C33			CK73GB1E103K	CHIP C 0.010UF K		C98			CC73GCH1H150J	CHIP C 15PF J	
C34		*	CS77CC1C220M	CHIP TNTL 22UF 16WV		C99			CK73GB1H102K	CHIP C 1000PF K	
C35			CC73GCH1H101J	CHIP C 100PF J		C100			CS77BA1A100M	CHIP TNTL 10UF 10WV	TK-980
C36			CS77BA1A100M	CHIP TNTL 10UF 10WV		C102			CC73GCH1H270J	CHIP C 27PF J	
C37		*	C92-0930-05	ELECTRO 100UF 16WV		C103			CK73GB1C104K	CHIP C 0.10UF K	
C38			CS77BA0J4R7M	CHIP TNTL 4.7UF 6.3WV		C104			CK73GB1E103K	CHIP C 0.010UF K	
C39			CK73GB1E103K	CHIP C 0.010UF K		C105			CS77CA1C010M	CHIP TNTL 1.0UF 16WV	
C40			CC73GCH1H101J	CHIP C 100PF J		C106			CK73GB1H102K	CHIP C 1000PF K	
C41,42			CS77BA1A100M	CHIP TNTL 10UF 10WV		C107			CS77BA1A100M	CHIP TNTL 10UF 10WV	
C43,44			CC73GCH1H101J	CHIP C 100PF J		C108			CK73GB1C104K	CHIP C 0.10UF K	
C45			CS77BA0J4R7M	CHIP TNTL 4.7UF 6.3WV		C109,110			CK73GB1H102K	CHIP C 1000PF K	
C46			CS77CA1C010M	CHIP TNTL 1.0UF 16WV		C111			CC73GCH1H101J	CHIP C 100PF J	
C47			CC73GCH1H101J	CHIP C 100PF J		C112			CK73GB1H102K	CHIP C 1000PF K	
C48			CK73FF1C105Z	CHIP C 1.0UF Z		C113			CK73GB1E103K	CHIP C 0.010UF K	
C49			CC73GCH1H101J	CHIP C 100PF J		C114			CS77CA1A3R3M	CHIP TNTL 3.3UF 10WV	
C51			CC73GCH1H101J	CHIP C 100PF J		C115			CK73GB1H102K	CHIP C 1000PF K	
C52			CC73GCH1H100D	CHIP C 10PF D		C116			CS77BA0J4R7M	CHIP TNTL 4.7UF 6.3WV	
C54			CK73GB1C104K	CHIP C 0.10UF K		C117			CK73GB1E103K	CHIP C 0.010UF K	
C55			CC73GCH1H030C	CHIP C 3.0PF C		C118			CK73GB1C104K	CHIP C 0.10UF K	
C56			CC73GCH1H101J	CHIP C 100PF J		C121			CS77CA1A3R3M	CHIP TNTL 3.3UF 10WV	
C57			CK73GB1E103K	CHIP C 0.010UF K		C123			CK73GB1C104K	CHIP C 0.10UF K	
C58			CC73GCH1H101J	CHIP C 100PF J		C124,125			CK73GB1H102K	CHIP C 1000PF K	
C59			CC73GCH1H030C	CHIP C 3.0PF C		C126			CK73GB1C104K	CHIP C 0.10UF K	
C60			CC73GCH1H101J	CHIP C 100PF J		C127			CK73GB1E103K	CHIP C 0.010UF K	
C61			CK73GB1E103K	CHIP C 0.010UF K		C128,129			CC73GCH1H470J	CHIP C 47PF J	
C62			CC73GCH1H030C	CHIP C 3.0PF C		C131			CC73GCH1H101J	CHIP C 100PF J	
C63			CK73FF1C105Z	CHIP C 1.0UF Z		C132			CK73GB1C104K	CHIP C 0.10UF K	
C64			CC73GCH1H101J	CHIP C 100PF J		C134			CK73FB1C224K	CHIP C 0.22UF K	
C65			CK73GB1C104K	CHIP C 0.10UF K		C136			CK73FB1C224K	CHIP C 0.22UF K	
C66			CK73GB1E103K	CHIP C 0.010UF K		C137			CK73GB1H471K	CHIP C 470PF K	
C67			CC73GCH1H101J	CHIP C 100PF J		C142,143			CK73GB1H471K	CHIP C 470PF K	
C68			CK73GB1C104K	CHIP C 0.10UF K		C144			CK73GB1H102K	CHIP C 1000PF K	
C70			CE32BD1E470M	CHIP EL 47UF 25WV		C150			CC73GCH1H220J	CHIP C 22PF J	
C71			CK73GB1C104K	CHIP C 0.10UF K		C151			CK73GB1H102K	CHIP C 1000PF K	
C72,73			CK73GB1H102K	CHIP C 1000PF K		C152			C92-0777-05	ELECTRO 1000UF 25WV	
C74			CE32BD1E470M	CHIP EL 47UF 25WV		C153			CC73GCH1H100D	CHIP C 10PF D	
C75			C92-0881-05	ELECTRO 47UF 10WV		C155			CK73GB1H102K	CHIP C 1000PF K	
C76			CK73GB1H102K	CHIP C 1000PF K		C156			CK73GB1E103K	CHIP C 0.010UF K	
						C157			CK73GB1C104K	CHIP C 0.10UF K	

PARTS LIST

TX-RX UNIT (X57-6520-XX)

Ref. No.	Address	New parts	Parts No.	Description	Desti-nation	Ref. No.	Address	New parts	Parts No.	Description	Desti-nation
C158,159			CC73GCH1H040C	CHIP C 4.0PF C		C262			CE32BD1E470M	CHIP EL 47UF 25WV	
C160			CK73GB1C104K	CHIP C 0.10UF K		C263			CK73GB1H102K	CHIP C 1000PF K	
C161			CC73GCH1H101J	CHIP C 100PF J		C264			CK73GB1C104K	CHIP C 0.10UF K	
C162			C92-0949-05	TANTAL 4.7UF 16WV		C265			C93-0550-05	CHIP C 1.0PF C	TK-980
C164			CK73GB1H471K	CHIP C 470PF K		C265,266			C93-0550-05	CHIP C 1.0PF C	TK-981
C166			CK73GB1C104K	CHIP C 0.10UF K		C266			C93-0553-05	CHIP C 3.0PF C	TK-980
C167			CC73GCH1H100D	CHIP C 10PF D		C267			C93-0568-05	CHIP C 47PF J	
C168			CC73GCH1H080D	CHIP C 8.0PF D		C268			CC73FCH1H010C	CHIP C 1.0PF C	TK-981
C169			CK73GB1H102K	CHIP C 1000PF K		C268			CC73FCH1H470J	CHIP C 47PF J	TK-980
C170			CC73GCH1H050C	CHIP C 5.0PF C	TK-981	C269			C93-0560-05	CHIP C 10PF D	
C170			CC73GCH1H070B	CHIP C 7.0PF B	TK-980	C271			C93-0550-05	CHIP C 1.0PF C	
C171			CC73GCH1H101J	CHIP C 100PF J		C272			CC73GCH1H010C	CHIP C 1.0PF C	
C172			CK73GB1C104K	CHIP C 0.10UF K		C273			C93-0552-05	CHIP C 2.0PF C	TK-981
C173			CK73GB1E103K	CHIP C 0.010UF K		C273			C93-0553-05	CHIP C 3.0PF C	TK-980
C174			C92-0949-05	TANTAL 4.7UF 16WV		C274			CC73GCH1H221J	CHIP C 220PF J	
C175			CC73GCH1H101J	CHIP C 100PF J	TK-980	C275			CS77CA1VR22M	CHIP TNTL 0.22UF 35WV	
C175,176			CC73GCH1H101J	CHIP C 100PF J	TK-981	C276			CS77CA1D4R7M	CHIP TNTL 4.7UF 20WV	TK-980
C176			CC73GCH1H470J	CHIP C 47PF J	TK-980	C276			C92-0657-05	CHIP TNTL 2.2UF 20WV	TK-981
C177		*	CS77BA1E010M	CHIP TNTL 1.0UF 25WV		C284			CC73GCH1H470J	CHIP C 47PF J	
C178			CC73GCH1H470J	CHIP C 47PF J	TK-980	C286			CC73GCH1H470J	CHIP C 47PF J	
C179			CC73GCH1H101J	CHIP C 100PF J	TK-981	C289			CK73GB1E103K	CHIP C 0.010UF K	
C184			CS77BA1A100M	CHIP TNTL 10UF 10WV	TK-981	C307			CK73GB1H103K	CHIP C 0.010UF K	
C195-198			CK73GB1H102K	CHIP C 1000PF K		C308			CC73GCH1H2R5B	CHIP C 2.5PF B	
C207			CC73GCH1H101J	CHIP C 100PF J		C309			CC73GCH1H0R5B	CHIP C 0.5PF B	TK-981
C209			CC73GCH1H101J	CHIP C 100PF J		C309			CC73GCH1H010B	CHIP C 1.0PF B	TK-980
C210			CC73GCH1H030C	CHIP C 3.0PF C	TK-981	C310			CC73GCH1H1R5B	CHIP C 1.5PF B	TK-981
C210			CC73GCH1H040C	CHIP C 4.0PF C	TK-980	C310			CC73GCH1H2R5B	CHIP C 2.5PF B	TK-980
C211			CC73GCH1H101J	CHIP C 100PF J		C314			CS77CA1V0R1M	CHIP TNTL 0.1UF 35WV	
C212			CC73GCH1H050C	CHIP C 5.0PF C		C317			CC73GCH1H101J	CHIP C 100PF J	
C213			CC73GCH1H010B	CHIP C 1.0PF B		C320			CS77CA1A6R8M	CHIP TNTL 6.8UF 10WV	TK-980
C214,215			CC73GCH1H101J	CHIP C 100PF J		C320			CS77CA1E010M	CHIP TNTL 1.0UF 25WV	TK-981
C216			CC73GCH1H010B	CHIP C 1.0PF B	TK-981	C321			CC73GCH1H040C	CHIP C 4.0PF C	
C216			CC73GCH1H1R5B	CHIP C 1.5PF B	TK-980	C322			CS77CA1A6R8M	CHIP TNTL 6.8UF 10WV	TK-980
C217			CK73GB1H102K	CHIP C 1000PF K		C322			CS77CA1E010M	CHIP TNTL 1.0UF 25WV	TK-981
C218			CC73GCH1H101J	CHIP C 100PF J		C325			CS77CA1DR68M	CHIP TNTL 0.68UF 20WV	TK-980
C219			CC73GCH1H110J	CHIP C 11PF J	TK-980	C325			CS77CA1ER47M	CHIP TNTL 0.47UF 25WV	TK-981
C219			CC73GCH1H120J	CHIP C 12PF J	TK-981	C326			CK73FB1C154K	CHIP C 0.15UF K	
C220			CC73GCH1H101J	CHIP C 100PF J		C327			CC73GCH1H101J	CHIP C 100PF J	
C221			CK73GB1H102K	CHIP C 1000PF K		C328			CK73GB1H471K	CHIP C 470PF K	
C222			CC73GCH1H101J	CHIP C 100PF J		C330			CC73FCH1H150J	CHIP C 15PF J	TK-980
C224			CK73GB1H102K	CHIP C 1000PF K		C330			CC73FCH1H470J	CHIP C 47PF J	TK-981
C227			CK73GB1H103K	CHIP C 0.010UF K		C331,332			CC73GCH1H101J	CHIP C 100PF J	
C228			CK73GB1H102K	CHIP C 1000PF K		C401-405			CC73GCH1H020B	CHIP C 2.0PF B	
C229			CK73GB1H103K	CHIP C 0.010UF K		C437			CK73GB1H102K	CHIP C 1000PF K	
C234			CC73GCH1H101J	CHIP C 100PF J	TK-981	C438			CC73GCH1H220J	CHIP C 22PF J	
C234			CC73GCH1H150J	CHIP C 15PF J	TK-980	C440			CK73GB1C104K	CHIP C 0.10UF K	
C235			CC73GCH1H020B	CHIP C 2.0PF B		C441			CC73GCH1H101J	CHIP C 100PF J	
C236			CC73GCH1H101J	CHIP C 100PF J		C442			CK73GB1H102K	CHIP C 1000PF K	
C240			CK73GB1E103K	CHIP C 0.010UF K		C443			CK73GB1C104K	CHIP C 0.10UF K	
C245			CC73GCH1H101J	CHIP C 100PF J		C444			CC73GCH1H101J	CHIP C 100PF J	
C246			CS77CA1V0R1M	CHIP TNTL 0.1UF 35WV		C445			CK73GB1H102K	CHIP C 1000PF K	
C247			CC73GCH1H101J	CHIP C 100PF J		C446			CK73GB1C104K	CHIP C 0.10UF K	
C249			CC73GCH1H100D	CHIP C 10PF D		C447			CK73GB1H102K	CHIP C 1000PF K	
C252			CK73GB1H102K	CHIP C 1000PF K		C448			CK73GB1H103K	CHIP C 0.010UF K	
C253			CC73FCH1H060D	CHIP C 6.0PF D	TK-980	C449			CC73GCH1H560J	CHIP C 56PF J	
C253			CC73FCH1H080D	CHIP C 8.0PF D	TK-981	C450			CK73GB1H102K	CHIP C 1000PF K	
C255			CC73FCH1H040C	CHIP C 4.0PF C	TK-981	C451			CC73GCH1H101J	CHIP C 100PF J	
C255			CC73FCH1H100D	CHIP C 10PF D	TK-980	C453			CK73GB1H102K	CHIP C 1000PF K	
C256			CK73GB1H102K	CHIP C 1000PF K		C454			CK73GB1H103K	CHIP C 0.010UF K	
C258			CK73GB1C104K	CHIP C 0.10UF K		C455			CC73GCH1H101J	CHIP C 100PF J	

PARTS LIST

TX-RX UNIT (X57-6520-XX)

Ref. No.	Address	New parts	Parts No.	Description	Destination	Ref. No.	Address	New parts	Parts No.	Description	Destination
C456			CK73GB1H102K	CHIP C 1000PF K		C571			CK73GB1H102K	CHIP C 1000PF K	
C457			CK73GB1C104K	CHIP C 0.10UF K		C572			CK73FB1H563K	CHIP C 0.056UF K	
C458,459			CC73GCH1H101J	CHIP C 100PF J		C574			CK73GB1C104K	CHIP C 0.10UF K	
C460			CK73GB1H103K	CHIP C 0.010UF K		C575			CK73FB1C334K	CHIP C 0.33UF K	
C461-464			CK73GB1C104K	CHIP C 0.10UF K		C576			CK73GB1C473K	CHIP C 0.047UF K	
C465-471			CC73GCH1H101J	CHIP C 100PF J	TK-981	C577			CK73GB1C104K	CHIP C 0.10UF K	
C501			CK73GB1H471K	CHIP C 470PF K		C578			CK73GB1H103K	CHIP C 0.010UF K	
C503,504			CK73GB1H471K	CHIP C 470PF K		C579			CK73GB1H472K	CHIP C 4700PF K	
C505			CK73GB1C683K	CHIP C 0.068UF K		C580			CK73GB1H102K	CHIP C 1000PF K	
C506			CK73GB1E123K	CHIP C 0.012UF K		C582			CK73GB1H103K	CHIP C 0.010UF K	
C509			CK73GB1H222K	CHIP C 2200PF K		C583			CK73GB1H102K	CHIP C 1000PF K	
C510			CS77BA0J4R7M	CHIP TNTL 4.7UF 6.3WV		C584			CK73GB1H471K	CHIP C 470PF K	
C511			CK73GB1H103K	CHIP C 0.010UF K		C592			CK73GB1H102K	CHIP C 1000PF K	
C512			CK73GB1H471K	CHIP C 470PF K		C593			CK73GB1H223K	CHIP C 0.022UF K	TK-981
C513			CK73GB1H102K	CHIP C 1000PF K		C593			CK73GB1H473K	CHIP C 0.047UF K	TK-980
C514			CK73GB1H152K	CHIP C 1500PF K		C594,595			CC73GCH1H150J	CHIP C 15PF J	TK-981
C515			CK73GB1C104K	CHIP C 0.10UF K		C594,595			CC73GCH1H180J	CHIP C 18PF J	TK-980
C516,517			CK73GB1H103K	CHIP C 0.010UF K		C596			CC73GCH1H040B	CHIP C 4.0PF B	TK-980
C518			CK73GB1H102K	CHIP C 1000PF K		C597			CK73GB1H103K	CHIP C 0.010UF K	TK-980
C519			CS77BA0J4R7M	CHIP TNTL 4.7UF 6.3WV		C598,599			CC73GCH1H101J	CHIP C 100PF J	
C520			CC73GCH1H121J	CHIP C 120PF J		C600,601			CK73GB1H102K	CHIP C 1000PF K	
C521,522			CK73GB1C104K	CHIP C 0.10UF K		C602			CK73GB1H103K	CHIP C 0.010UF K	
C523			CK73GB1H103K	CHIP C 0.010UF K		C603			CK73GB1C104K	CHIP C 0.10UF K	
C524			CK73GB1C104K	CHIP C 0.10UF K		C604			CS77BA0J100M	CHIP TNTL 10UF 6.3WV	
C525			CK73GB1H103K	CHIP C 0.010UF K		C605			CK73GB1H102K	CHIP C 1000PF K	
C526			CK73GB1C104K	CHIP C 0.10UF K		C606			CK73GB1H472K	CHIP C 4700PF K	
C527			CK73GB1C333K	CHIP C 0.033UF K		C607			CK73GB1C104K	CHIP C 0.10UF K	
C528			CK73GB1H102K	CHIP C 1000PF K		C608			CK73GB1H392K	CHIP C 3900PF K	
C529			CK73GB1H562K	CHIP C 5600PF K		C609,610			CK73GB1H103K	CHIP C 0.010UF K	
C531			CK73GB1H562K	CHIP C 5600PF K		C612			CK73GB1H103K	CHIP C 0.010UF K	
C533			CK73GB1H562K	CHIP C 5600PF K		C613			CS77AA1A4R7M	CHIP TNTL 4.7UF 10WV	TK-980
C535			CK73GB1H102K	CHIP C 1000PF K		C613	*		CS77BA1A4R7M	CHIP TNTL 4.7UF 10WV	TK-981
C536			CC73GCH1H030C	CHIP C 3.0PF C		C614			CK73GB1H102K	CHIP C 1000PF K	
C537			CK73GB1H272K	CHIP C 2700PF K		C616			CK73GB1H102K	CHIP C 1000PF K	
C539			CK73GB1H272K	CHIP C 2700PF K		C617			CC73GCH1H101J	CHIP C 100PF J	
C540			CC73GCH1H271J	CHIP C 270PF J		C620			CC73GCH1H101J	CHIP C 100PF J	
C541			CC73GCH1H151J	CHIP C 150PF J		C622,623			CK73GB1H102K	CHIP C 1000PF K	
C542			CC73GCH1H271J	CHIP C 270PF J		C624			CC73GCH1H101J	CHIP C 100PF J	
C543			CK73GB1H272K	CHIP C 2700PF K		C625			CK73GB1H102K	CHIP C 1000PF K	
C544			CC73GCH1H030C	CHIP C 3.0PF C		C626			CC73GCH1H101J	CHIP C 100PF J	
C545			CK73GB1H102K	CHIP C 1000PF K		C627			CK73GB1H102K	CHIP C 1000PF K	
C546			CK73GB1H122K	CHIP C 1200PF K		C628			CC73GCH1H101J	CHIP C 100PF J	
C547			CK73GB1H102K	CHIP C 1000PF K		C630			CK73GB1H102K	CHIP C 1000PF K	
C548			CS77BA0J220M	CHIP TNTL 22UF 6.3WV		C631-634			CC73GCH1H101J	CHIP C 100PF J	
C549			CK73GB1C104K	CHIP C 0.10UF K		C714			CC73GCH1H331J	CHIP C 330PF J	
C550			CC73GCH1H101J	CHIP C 100PF J		C715			CK73GB1H102K	CHIP C 1000PF K	
C552			CK73GB1C333K	CHIP C 0.033UF K		C718			CS77BA0J220M	CHIP TNTL 22UF 6.3WV	
C553			CK73GB1H472K	CHIP C 4700PF K		C720			CC73GCH1H470J	CHIP C 47PF J	
C554-558			CK73GB1C104K	CHIP C 0.10UF K		C722,723			CC73GCH1H221J	CHIP C 220PF J	
C559			CK73GB1H102K	CHIP C 1000PF K		C726			CK73GB1C104K	CHIP C 0.10UF K	
C560			CS77BA0J4R7M	CHIP TNTL 4.7UF 6.3WV		C728			C92-0888-05	TANTAL 10U 6.3WV	
C561			CK73GB1H102K	CHIP C 1000PF K		C729			CK73GB1H103K	CHIP C 0.010UF K	
C562,563			CK73GB1H472K	CHIP C 4700PF K		C730			CK73HB1E103K	CHIP C 0.010UF K	
C564			CK73GB1E223K	CHIP C 0.022UF K		CN1			E41-2834-05	PIN ASSY	
C565			CK73GB1H102K	CHIP C 1000PF K		CN2			E41-3085-05	PIN ASSY	
C566			CC73GCH1H101J	CHIP C 100PF J		CN3			E41-1683-05	PIN ASSY	
C567			CK73GB1E223K	CHIP C 0.022UF K		CN4	*		E41-3085-05	PIN ASSY	
C568			CS77BA0J220M	CHIP TNTL 22UF 6.3WV		CN5			E41-1683-05	PIN ASSY	
C569			CC73GCH1H470J	CHIP C 47PF K		CN6			E41-1682-05	PIN ASSY	
C570			CK73GB1C104K	CHIP C 0.10UF K		CN7	*		E40-6804-05	FLAT CABLE CONNECTOR	

TK-980/981

PARTS LIST

TX-RX UNIT (X57-6520-XX)

Ref. No.	Address	New parts	Parts No.	Description	Desti-nation	Ref. No.	Address	New parts	Parts No.	Description	Desti-nation
CN501			E40-6452-05FLAT	CABLE CONNECTOR		R15			RK73GB2A103J	CHIP R 10K J 1/10W	
CN502		*	E40-6804-05	FLAT CABLE CONNECTOR		R16			RK73GB2A333J	CHIP R 33K J 1/10W	
J1			E11-0442-05	3.5D PHONE JACK(3P)		R17			RK73GB2A000J	CHIP R 0.0 J 1/10W	
J501			E58-0522-05	MODULAR JACK		R19			RK73GB2A153J	CHIP R 15K J 1/10W	
			J31-0543-05	COLLAR		R20			RK73GB2A104J	CHIP R 100K J 1/10W	
CF1			L72-0986-05	CERAMIC FILTER	TK-981	R21			RK73GB2A563J	CHIP R 56K J 1/10W	
CF1			L72-0998-05	CERAMIC FILTER	TK-980	R22			RK73GB2A104J	CHIP R 100K J 1/10W	
L1		*	L41-4795-33	SMALL FIXED INDUCTOR(4.7UH)		R23			RK73GB2A224J	CHIP R 220K J 1/10W	
L3,4			L40-1875-92	SMALL FIXED INDUCTOR(18NH)		R25			RK73GB2A394J	CHIP R 390K J 1/10W	
L5			L41-1095-33	SMALL FIXED INDUCTOR(1.0UH)		R26			RK73GB2A104J	CHIP R 100K J 1/10W	
L6			L34-4787-05	COIL		R27			RK73GB2A473J	CHIP R 47K J 1/10W	
L8			L92-0138-05	CHIP FERRITE		R29			RK73GB2A220J	CHIP R 22 J 1/10W	
L9			L40-8265-92	SMALL FIXED INDUCTOR(8.2NH)		R30			RK73GB2A224J	CHIP R 220K J 1/10W	
L10			L41-1095-33	SMALL FIXED INDUCTOR(1.0UH)		R31			RK73GB2A104J	CHIP R 100K J 1/10W	
L205			L40-1075-92	SMALL FIXED INDUCTOR(10NH)		R32,33			RK73GB2A474J	CHIP R 470K J 1/10W	
L206			L40-6865-92	SMALL FIXED INDUCTOR(6.8NH)	TK-981	R34			RK73GB2A000J	CHIP R 0.0 J 1/10W	
L206			L40-8265-92	SMALL FIXED INDUCTOR(8.2NH)	TK-980	R36			RK73GB2A103J	CHIP R 10K J 1/10W	
L208			L40-4763-92	SMALL FIXED INDUCTOR(4.7NH)		R37			RK73GB2A000J	CHIP R 0.0 J 1/10W	
L209			L40-8265-92	SMALL FIXED INDUCTOR(8.2NH)		R39			RK73GB2A101J	CHIP R 100 J 1/10W	
L210			L40-3985-45	SMALL FIXED INDUCTOR(0.39UH)		R40			RK73GB2A472J	CHIP R 4.7K J 1/10W	
L211			L40-6885-45	SMALL FIXED INDUCTOR(0.68UH)		R41			RK73GB2A183J	CHIP R 18K J 1/10W	
L218			L40-1075-38	SMALL FIXED INDUCTOR(10NH)		R42			RK73GB2A333J	CHIP R 33K J 1/10W	
L220			L34-1306-15	AIR-CORE COIL		R44,45			RK73GB2A154J	CHIP R 150K J 1/10W	
L221			L34-1317-05	AIR-CORE COIL		R46			RK73GB2A104J	CHIP R 100K J 1/10W	
L222,223			L34-1307-05	AIR-CORE COIL	TK-980	R47			RK73GB2A473J	CHIP R 47K J 1/10W	
L222,223			L34-1313-05	AIR-CORE COIL	TK-981	R48			RK73GB2A123J	CHIP R 12K J 1/10W	
L224			L34-1306-15	AIR-CORE COIL		R49,50			RK73GB2A103J	CHIP R 10K J 1/10W	
L225			L92-0179-05	CHIP FERRITE		R52			RK73GB2A104J	CHIP R 100K J 1/10W	
L226			L40-1075-38	SMALL FIXED INDUCTOR(10NH)		R53			RK73GB2A000J	CHIP R 0.0 J 1/10W	
L229			L34-1308-15	AIR-CORE COIL		R54			RK73GB2A154J	CHIP R 150K J 1/10W	
L230,231		*	L79-1910-05	DIELECTRIC FILTER	TK-980	R55			RK73GB2A104J	CHIP R 100K J 1/10W	
L230,231		*	L79-1911-05	DIELECTRIC FILTER	TK-981	R56			RK73GB2A103J	CHIP R 10K J 1/10W	
L300			L40-1563-92	SMALL FIXED INDUCTOR(1.5NH)		R57			RK73GB2A473J	CHIP R 47K J 1/10W	
L301			L40-4763-92	SMALL FIXED INDUCTOR(4.7NH)		R58			RK73GB2A102J	CHIP R 1.0K J 1/10W	
L303,304			L40-2763-92	SMALL FIXED INDUCTOR(2.7NH)		R60			RK73GB2A472J	CHIP R 4.7K J 1/10W	
L305			L92-0179-05	CHIP FERRITE		R61			RK73GB2A103J	CHIP R 10K J 1/10W	
L310-312			L40-8265-92	SMALL FIXED INDUCTOR(8.2NH)		R62			RK73GB2A101J	CHIP R 100 J 1/10W	
L313			L92-0140-05	CHIP FERRITE		R63-65			RK73GB2A000J	CHIP R 0.0 J 1/10W	
L501-508			L92-0138-05	CHIP FERRITE		R66			RK73GB2A682J	CHIP R 6.8K J 1/10W	
X1			L77-3028-05	TCXO(16.8MHZ)		R67			RK73GB2A470J	CHIP R 47 J 1/10W	
X2			L77-1762-05	CRYSTAL RESONATOR(44.395MHZ)		R69			RK73GB2A102J	CHIP R 1.0K J 1/10W	
X501		*	L77-1708-15	CRYSTAL RESONATOR(3.579545MHZ)		R70-73			RK73GB2A000J	CHIP R 0.0 J 1/10W	
X502		*	L77-3038-05	CRYSTAL RESONATOR(9.8304MHZ)		R74			RK73GB2A473J	CHIP R 47K J 1/10W	
XF1			L71-0525-05	MCF(5KHZ)	TK-980	R75			RK73GB2A102J	CHIP R 1.0K J 1/10W	
XF1			L71-0583-05	MCF(44.85MHZ)	TK-981	R76			RK73GB2A153J	CHIP R 15K J 1/10W	
CP501			RK75GB1J102J	CHIP-COM 1.0K J 1/16W		R77			RK73GB2A333J	CHIP R 33K J 1/10W	
R1			RK73GB2A102J	CHIP R 1.0K J 1/10W		R78			RK73GB2A104J	CHIP R 100K J 1/10W	
R2			RK73GB2A000J	CHIP R 0.0 J 1/10W		R79			RK73GB2A180J	CHIP R 18 J 1/10W	TK-981
R3			RK73GB2A101J	CHIP R 100 J 1/10W		R79			RK73GB2A390J	CHIP R 39 J 1/10W	TK-980
R4			RK73GB2A102J	CHIP R 1.0K J 1/10W		R80			RK73GB2A473J	CHIP R 47K J 1/10W	
R6,7			RK73GB2A000J	CHIP R 0.0 J 1/10W		R82,83			RK73GB2A151J	CHIP R 150 J 1/10W	TK-980
R8			RK73GB2A102J	CHIP R 1.0K J 1/10W		R82,83			RK73GB2A271J	CHIP R 270 J 1/10W	TK-981
R9			RK73GB2A000J	CHIP R 0.0 J 1/10W		R85			RK73GB2A821J	CHIP R 820 J 1/10W	
R10,11			RK73GB2A102J	CHIP R 1.0K J 1/10W		R86,87			RK73GB2A000J	CHIP R 0.0 J 1/10W	
R12			RK73GB2A000J	CHIP R 0.0 J 1/10W		R88			RK73EB2E181J	CHIP R 180 J 1/4W	
R14			RK73GB2A473J	CHIP R 47K J 1/10W		R89			RK73EB2E151J	CHIP R 150 J 1/4W	
						R90			RK73GB2A2R2J	CHIP R 2.2 J 1/10W	
						R91			RK73GB2A472J	CHIP R 4.7K J 1/10W	
						R92			RK73FB2B472J	CHIP R 4.7K J 1/8W	
						R93			RK73FB2B470J	CHIP R 47 J 1/8W	

PARTS LIST

TX-RX UNIT (X57-6520-XX)

Ref. No.	Address	New parts	Parts No.	Description	Desti-nation	Ref. No.	Address	New parts	Parts No.	Description	Desti-nation
R94			RK73GB2A000J	CHIP R 0.0 J 1/10W		R211			RK73GB2A101J	CHIP R 100 J 1/10W	
R95			RK73FB2B154J	CHIP R 150K J 1/8W		R212			RK73GB2A5R6J	CHIP R 5.6 J 1/10W	
R96			RK73GB2A181J	CHIP R 180 J 1/10W	TK-981	R214			RK73GB2A221J	CHIP R 220 J 1/10W	
R96			RK73GB2A331J	CHIP R 330 J 1/10W	TK-980	R217			RK73GB2A101J	CHIP R 100 J 1/10W	
R97,98			RK73GB2A473J	CHIP R 47K J 1/10W		R218			RK73GB2A473J	CHIP R 47K J 1/10W	
R99			RK73GB2A152J	CHIP R 1.5K J 1/10W		R219			RK73GB2A273J	CHIP R 27K J 1/10W	
R100			RK73GB2A151J	CHIP R 150 J 1/10W	TK-981	R220			RK73GB2A473J	CHIP R 47K J 1/10W	
R100			RK73GB2A331J	CHIP R 330 J 1/10W	TK-980	R221			RK73GB2A153J	CHIP R 15K J 1/10W	
R101			RK73FB2B470J	CHIP R 47 J 1/8W		R223			RK73GB2A102J	CHIP R 1.0K J 1/10W	
R102			RK73FB2B102J	CHIP R 1.0K J 1/8W		R236			RK73GB2A470J	CHIP R 47 J 1/10W	
R103			RK73FB2B223J	CHIP R 22K J 1/8W		R237			RK73GB2A153J	CHIP R 15K J 1/10W	
R104			RK73FB2B473J	CHIP R 47K J 1/8W		R239			RK73GB2A154J	CHIP R 150K J 1/10W	
R105		*	R92-3630-05	CHIP R 3.9K J 1/8W		R240			RK73GB2A333J	CHIP R 33K J 1/10W	
R106			RK73GB2A000J	CHIP R 0.0 J 1/10W		R247		*	RK73RB2H390J	CHIP R 39 J 1/2W	
R107			RK73GB2A473J	CHIP R 47K J 1/10W		R248,249			RK73RB2H121J	CHIP R 120 J 1/2W	TK-980
R109			RK73FB2B000J	CHIP R 0.0 J 1/8W		R248,249			RK73RB2H151J	CHIP R 150 J 1/2W	TK-981
R110			RK73GB2A470J	CHIP R 47 J 1/10W		R250			RK73GB2A470J	CHIP R 47 J 1/10W	
R111			RK73GB2A472J	CHIP R 4.7K J 1/10W		R251			RK73GB2A474J	CHIP R 470K J 1/10W	
R112,113		*	R92-3629-05	CHIP R 4.7K B 1/8W		R252			RK73RB2H000J	CHIP R 0.0 J 1/2W	
R116			RK73GB2A473J	CHIP R 47K J 1/10W		R253,254			RK73GB2A821J	CHIP R 820 J 1/10W	
R118			RK73GB2A392J	CHIP R 3.9K J 1/10W	TK-980	R255,256			R92-1308-05	CHIP R 22 J 1W	
R119			RK73GB2A103J	CHIP R 10K J 1/10W		R257,258			RK73FB2B000J	CHIP R 0.0 J 1/8W	
R120		*	R92-3629-05	CHIP R 4.7K B 1/8W		R260			RK73FB2B153J	CHIP R 15K J 1/8W	
R121			RK73GB2A472J	CHIP R 4.7K J 1/10W		R261			RK73FB2B182J	CHIP R 1.8K J 1/8W	
R122			RK73FB2B272J	CHIP R 2.7K J 1/8W		R306			RK73GB2A102J	CHIP R 1.0K J 1/10W	TK-980
R124			RK73GB2A223J	CHIP R 22K J 1/10W		R306			RK73GB2A182J	CHIP R 1.8K J 1/10W	TK-981
R127		*	R92-2682-05	CHIP R 0.22 B 1/8W		R308			RK73GB2A101J	CHIP R 100 J 1/10W	
R128			RK73GB2A223J	CHIP R 22K J 1/10W		R309			RK73GB2A104J	CHIP R 100K J 1/10W	TK-981
R129			RK73GB2A100J	CHIP R 10 J 1/10W		R309			RK73GB2A333J	CHIP R 33K J 1/10W	TK-980
R132			RK73GB2A104J	CHIP R 100K J 1/10W		R310			RK73GB2A103J	CHIP R 10K J 1/10W	TK-980
R134			RK73GB2A473J	CHIP R 47K J 1/10W		R310			RK73GB2A473J	CHIP R 47K J 1/10W	TK-981
R135			RK73RB2H151J	CHIP R 150 J 1/2W		R311			RK73GB2A561J	CHIP R 560 J 1/10W	
R137			RK73GB2A473J	CHIP R 47K J 1/10W		R312			RK73GB2A222J	CHIP R 2.2K J 1/10W	TK-981
R139			RK73GB2A102J	CHIP R 1.0K J 1/10W		R312			RK73GB2A471J	CHIP R 470 J 1/10W	TK-980
R140			RK73GB2A000J	CHIP R 0.0 J 1/10W		R315			RK73GB2A103J	CHIP R 10K J 1/10W	TK-981
R141			RK73GB2A104J	CHIP R 100K J 1/10W		R315			RK73GB2A473J	CHIP R 47K J 1/10W	TK-980
R143			RK73GB2A102J	CHIP R 1.0K J 1/10W		R316,317			RK73GB2A000J	CHIP R 0.0 J 1/10W	
R144			RK73GB2A223J	CHIP R 22K J 1/10W		R318			RK73GB2A331J	CHIP R 330 J 1/10W	TK-981
R145			RK73GB2A104J	CHIP R 100K J 1/10W		R318			RK73GB2A391J	CHIP R 390 J 1/10W	TK-980
R146			RK73RB2H471J	CHIP R 470 J 1/2W		R319			RK73GB2A102J	CHIP R 1.0K J 1/10W	
R148			RK73FB2B472J	CHIP R 4.7K J 1/8W		R321			RK73GB2A470J	CHIP R 47 J 1/10W	
R150			RK73FB2B000J	CHIP R 0.0 J 1/8W		R323			RK73GB2A470J	CHIP R 47 J 1/10W	TK-980
R151-153			RK73GB2A000J	CHIP R 0.0 J 1/10W		R323			RK73GB2A680J	CHIP R 68 J 1/10W	TK-981
R154			RK73GB2A103J	CHIP R 10K J 1/10W		R408			RK73GB2A000J	CHIP R 0.0 J 1/10W	
R155			RK73GB2A333J	CHIP R 33K J 1/10W		R411			RK73GB2A000J	CHIP R 0.0 J 1/10W	
R156			RK73GB2A471J	CHIP R 470 J 1/10W		R414			RK73GB2A000J	CHIP R 0.0 J 1/10W	
R157			RK73GB2A101J	CHIP R 100 J 1/10W		R417,418			RK73GB2A101J	CHIP R 100 J 1/10W	
R158,159			RK73GB2A000J	CHIP R 0.0 J 1/10W		R419			RK73GB2A220J	CHIP R 22 J 1/10W	
R160			RK73GB2A105J	CHIP R 1.0M J 1/10W		R420,421			RK73GB2A221J	CHIP R 220 J 1/10W	
R163			RK73GB2A104J	CHIP R 100K J 1/10W		R422			RK73GB2A220J	CHIP R 22 J 1/10W	
R166			RK73GB2A000J	CHIP R 0.0 J 1/10W		R423			RK73GB2A100J	CHIP R 10 J 1/10W	
R168			RK73GB2A000J	CHIP R 0.0 J 1/10W		R424-426			RK73GB2A000J	CHIP R 0.0 J 1/10W	
R170,171			RK73GB2A000J	CHIP R 0.0 J 1/10W		R427			RK73GB2A472J	CHIP R 4.7K J 1/10W	
R172			RK73GB2A221J	CHIP R 220 J 1/10W		R428			RK73GB2A101J	CHIP R 100 J 1/10W	
R176			RK73FB2B000J	CHIP R 0.0 J 1/8W		R429			RK73GB2A472J	CHIP R 4.7K J 1/10W	
R181,182			RK73EB2E000J	CHIP R 0.0 J 1/4W		R502			RK73GB2A184J	CHIP R 180K J 1/10W	
R183		*	R92-2682-05	CHIP R 0.22 B 1/8W		R503			RK73GB2A223J	CHIP R 22K J 1/10W	
R184			RK73EB2E000J	CHIP R 0.0 J 1/4W	TK-980	R504			RK73GB2A184J	CHIP R 180K J 1/10W	
R209			RK73GB2A103J	CHIP R 10K J 1/10W		R505			RK73GB2A102J	CHIP R 1.0K J 1/10W	
R210			RK73GB2A473J	CHIP R 47K J 1/10W		R506			RK73GB2A000J	CHIP R 0.0 J 1/10W	

PARTS LIST

TX-RX UNIT (X57-6520-XX)

Ref. No.	Address	New parts	Parts No.	Description	Destination	Ref. No.	Address	New parts	Parts No.	Description	Destination
R507,508			RK73GB2A154J	CHIP R 150K J 1/10W		R588			RK73GB2A473J	CHIP R 47K J 1/10W	
R512			RK73GB2A122J	CHIP R 1.2K J 1/10W		R612			RK73GB2A224J	CHIP R 220K J 1/10W	TK-981
R513			RK73GB2A000J	CHIP R 0.0 J 1/10W		R612			RK73GB2A274J	CHIP R 270K J 1/10W	TK-980
R515			RN73GH1J913D	CHIP R 91K D 1/16W		R614			RK73GB2A000J	CHIP R 0.0 J 1/10W	
R516			RK73GB2A102J	CHIP R 1.0K J 1/10W		R616			RK73GB2A473J	CHIP R 47K J 1/10W	
R518			RN73GH1J333D	CHIP R 33K D 1/16W		R624			RK73GB2A000J	CHIP R 0.0 J 1/10W	TK-980
R519			RN73GH1J913D	CHIP R 91K D 1/16W		R624			RK73GB2A471J	CHIP R 470 J 1/10W	TK-981
R520			RN73GH1J683D	CHIP R 68K D 1/16W		R633			RK73GB2A000J	CHIP R 0.0 J 1/10W	
R521			RK73GB2A105J	CHIP R 1.0M J 1/10W		R645			RK73GB2A182J	CHIP R 1.8K J 1/10W	TK-980
R522			RN73GH1J913D	CHIP R 91K D 1/16W		R658			RK73GB2A472J	CHIP R 4.7K J 1/10W	
R523			RK73GB2A154J	CHIP R 150K J 1/10W		R667,668			RK73GB2A181J	CHIP R 180 J 1/10W	
R524			RN73GH1J274D	CHIP R 270K D 1/16W		R670			RK73GB2A473J	CHIP R 47K J 1/10W	
R525			RK73GB2A334J	CHIP R 330K J 1/10W		R672,673			RK73GB2A473J	CHIP R 47K J 1/10W	
R526			RK73GB2A154J	CHIP R 150K J 1/10W		R674			RK73FB2B222J	CHIP R 2.2K J 1/8W	
R527			RK73GB2A103J	CHIP R 10K J 1/10W		R675			RK73GB2A472J	CHIP R 4.7K J 1/10W	
R528			RK73GB2A153J	CHIP R 15K J 1/10W		R676			RK73GB2A103J	CHIP R 10K J 1/10W	
R529			RK73GB2A000J	CHIP R 0.0 J 1/10W		R677			RK73GB2A223J	CHIP R 22K J 1/10W	
R530			RK73GB2A394J	CHIP R 390K J 1/10W		R678			RK73GB2A103J	CHIP R 10K J 1/10W	
R531			RK73GB2A473J	CHIP R 47K J 1/10W		R679			RK73FB2B390J	CHIP R 39 J 1/8W	
R532			RK73GB2A334J	CHIP R 330K J 1/10W		R680			RK73FB2B222J	CHIP R 2.2K J 1/8W	
R533			RK73GB2A000J	CHIP R 0.0 J 1/10W		R681			RK73GB2A223J	CHIP R 22K J 1/10W	
R535			RK73GB2A155J	CHIP R 1.5M J 1/10W		R682			RK73GB2A473J	CHIP R 47K J 1/10W	
R536			RN73GH1J682D	CHIP R 6.8K D 1/16W		R683			RK73GB2A103J	CHIP R 10K J 1/10W	
R537,538			RK73GB2A473J	CHIP R 47K J 1/10W		R684			RK73GB2A000J	CHIP R 0.0 J 1/10W	TK-981
R540			RK73GB2A474J	CHIP R 470K J 1/10W		R701			RK73GB2A102J	CHIP R 1.0K J 1/10W	
R541			RK73GB2A274J	CHIP R 270K J 1/10W		R702			RK73GB2A101J	CHIP R 100 J 1/10W	
R542			RN73GH1J683D	CHIP R 68K D 1/16W		R705,706			RK73GB2A473J	CHIP R 47K J 1/10W	
R544			RK73GB2A101J	CHIP R 100 J 1/10W		R716			RK73GB2A472J	CHIP R 4.7K J 1/10W	
R545			RK73GB2A182J	CHIP R 1.8K J 1/10W		R718			RK73GB2A154J	CHIP R 150K J 1/10W	
R546			RK73GB2A224J	CHIP R 220K J 1/10W		R719			RK73GB2A103J	CHIP R 10K J 1/10W	
R547			RK73GB2A103J	CHIP R 10K J 1/10W		R720			RK73GB2A683J	CHIP R 68K J 1/10W	
R548			RK73GB2A183J	CHIP R 18K J 1/10W		R721			RK73GB2A334J	CHIP R 330K J 1/10W	
R550			RN73GH1J682D	CHIP R 6.8K D 1/16W		R722	*		RK73FB2B680J	CHIP R 68 J 1/8W	
R551			RK73GB2A223J	CHIP R 22K J 1/10W		R723			RK73GB2A000J	CHIP R 0.0 J 1/10W	
R552			RK73GB2A334J	CHIP R 330K J 1/10W		R724			RK73GB2A392J	CHIP R 3.9K J 1/10W	
R553			RK73GB2A102J	CHIP R 1.0K J 1/10W		R725			RK73GB2A562J	CHIP R 5.6K J 1/10W	
R554			RK73GB2A332J	CHIP R 3.3K J 1/10W		R726,727			RK73GB2A000J	CHIP R 0.0 J 1/10W	
R555			RK73GB2A394J	CHIP R 390K J 1/10W		R733			RK73GB2A223J	CHIP R 22K J 1/10W	
R556			RK73GB2A223J	CHIP R 22K J 1/10W							
R558			RK73GB2A000J	CHIP R 0.0 J 1/10W		D1-6			DA204U	DIODE	
R562			RK73GB2A273J	CHIP R 27K J 1/10W		D7	*		UDZW20(B)	ZENER DIODE	
R564			RK73GB2A000J	CHIP R 0.0 J 1/10W		D11			DAN202U	DIODE	
R566			RK73GB2A470J	CHIP R 47 J 1/10W		D16			1SS355	DIODE	
R567			RK73GB2A220J	CHIP R 22 J 1/10W		D17			DA204U	DIODE	
R568			RK73GB2A473J	CHIP R 47K J 1/10W		D18,19			HVC131	DIODE	
R569			RK73GB2A103J	CHIP R 10K J 1/10W		D20			1SS355	DIODE	
R571			RK73GB2A102J	CHIP R 1.0K J 1/10W	TK-981	D21			UDZW5.6(B)	ZENER DIODE	
R571			RK73GB2A222J	CHIP R 2.2K J 1/10W	TK-980	D24			MINISMDC07502F	VARISTOR	
R572			RK73GB2A000J	CHIP R 0.0 J 1/10W		D26			1SS355	DIODE	
R573			RK73GB2A104J	CHIP R 100K J 1/10W		D28	*		UDZW15(B)	ZENER DIODE	
R574			RK73GB2A473J	CHIP R 47K J 1/10W		D31			1SS355	DIODE	
R575			RK73GB2A103J	CHIP R 10K J 1/10W		D32			22ZR-10D	SURGE ABSORBER	
R576			RK73GB2A473J	CHIP R 47K J 1/10W		D34	*		UDZW18(B)	ZENER DIODE	
R577			RK73GB2A153J	CHIP R 15K J 1/10W		D37			DSA3A1	DIODE	
R579			RK73GB2A000J	CHIP R 0.0 J 1/10W		D38			UDZW5.1(B)	ZENER DIODE	
R580			RK73GB2A103J	CHIP R 10K J 1/10W		D200			HSM88AS-E	DIODE	
R582			RK73GB2A000J	CHIP R 0.0 J 1/10W		D208-210	*		L709CER-TDIODE		
R584			RK73GB2A000J	CHIP R 0.0 J 1/10W		D401			1SS360-F	DIODE	
R585,586			RK73GB2A473J	CHIP R 47K J 1/10W		D501			DA204U	DIODE	
R587			RK73GB2A000J	CHIP R 0.0 J 1/10W		D502			MINISMDC07502F	VARISTOR	

PARTS LIST

TX-RX UNIT (X57-6520-XX)
PLL/VCO UNIT (X58-4530-XX)

Ref. No.	Address	New parts	Parts No.	Description	Desti-nation	Ref. No.	Address	New parts	Parts No.	Description	Desti-nation
D503-505			DA204U	DIODE		Q32			2SK1824-A	FET	
D507			DAN202U	DIODE		Q33			RT1N441U-T111	TRANSISTOR	
D508,509			MA3J742	DIODE		Q34		*	2SC2712-F(GR)	TRANSISTOR	
D510			HSC119	DIODE		Q201			2SC4094(R37)	TRANSISTOR	
D518		*	UDZW9.1(B)	ZENER DIODE		Q202			2SC3356-A(R24)	TRANSISTOR	
D520			MA2S111-F	DIODE		Q203			3SK255-A	FET	
IC1			TA75W01FUF	MOS-IC		Q204			2SK2596-E	FET	
IC2			TC75W51FUF	MOS-IC		Q205			RT1N441U-T111	TRANSISTOR	
IC3			TA75W558FU-F	MOS-IC		Q300			2SC4226-A(R24)	TRANSISTOR	
IC4		*	TC4S66F-F	MOS-IC		Q301,302			2SC3722K(S)	TRANSISTOR	
IC5			M62363FP-F	MOS-IC		Q400			2SA1832(GR)F	TRANSISTOR	
IC6			TA75W558FU-F	MOS-IC		Q501			DTC314TU	DIGITAL TRANSISTOR	
IC7,8			BU4094BCFV	MOS-IC		Q502			RT1N441U-T111	TRANSISTOR	
IC9			TA78L05FF	MOS-IC		Q503			2SC4617(S)	TRANSISTOR	
IC10			LA4422-E	BI-POLAR IC		Q507			RT1N441U-T111	TRANSISTOR	
IC11			TA31136FNG	MOS-IC		Q508,509			2SC4617(S)	TRANSISTOR	
IC12			TA78L05FF	MOS-IC		Q510			2SC4725	TRANSISTOR	TK-980
IC13			NJM2904E-ZB	ANALOGUE IC		Q511			DTA144WE	DIGITAL TRANSISTOR	
IC14			KIA7808API	MOS-IC		Q512			RT1N141U-T111	TRANSISTOR	
IC15			TC4013BF(N)-F	MOS-IC		Q513			*2SC2873(Y)F	TRANSISTOR	
IC16			NJM78L08UA-ZB	BI-POLAR IC		Q515			RT1N141U-T111	TRANSISTOR	
IC17			TC75S51FE(F)	MOS-IC		TH1			157-104-55001	THERMISTOR	
IC450			LMX2352TMX/NP	ANALOGUE IC		A1			X58-4530-10	SUB UNIT	TK-980
IC501			TA75W558FU-F	MOS-IC		A1			X58-4530-11	SUB UNIT	TK-981
IC502			TC75W51FUF	MOS-IC		PLL/VCO UNIT (X58-4530-XX)					
IC503			TA75W558FU-F	MOS-IC		C100			CK73GB1H471K	CHIP C 470PF K	
IC504			TC35453FG6	MOS-IC		C101			CC73GCH1H080B	CHIP C 8.0PF B	TK-980
IC506			BU4066BCFV	MOS-IC		C101			CC73GCH1H4R5B	CHIP C 4.5PF B	TK-981
IC507			LC73872M	MOS-IC		C102			CC73GCH1HR75B	CHIP C 0.75PF B	
IC508			BU4094BCFV	MOS-IC		C103			CK73GB1H471K	CHIP C 470PF K	
IC509			R3111H421C-F	MOS-IC		C104			CC73GCH1H010B	CHIP C 1.0PF B	TK-981
IC510			AT29C02090TU	ROM IC		C104			CC73GCH1H1R5B	CHIP C 1.5PF B	TK-980
IC511			30622MEP525GU	MCU		C105			CC73GCH1H040B	CHIP C 4.0PF B	TK-981
IC512			AT24C08BN-SH	ROM IC		C105			CC73GCH1H060B	CHIP C 6.0PF B	TK-980
IC513			TA78L05FF	MOS-IC		C106			CC73GCH1HR75B	CHIP C 0.75PF B	TK-980
IC711			TA75S01F-F	MOS-IC		C106,107			CC73GCH1HR75B	CHIP C 0.75PF B	TK-981
Q1			2SK1824-A	FET		C107			CC73GCH1H0R5B	CHIP C 0.5PF B	TK-980
Q2			2SC2412K(S)	TRANSISTOR		C108			CK73GB1H102K	CHIP C 1000PF K	
Q4			DTD114EK	DIGITAL TRANSISTOR		C109			CC73GCH1H030B	CHIP C 3.0PF B	
Q5,6			RT1N141U-T111	TRANSISTOR		C110			CC73GCH1H050B	CHIP C 5.0PF B	
Q7			2SC4226-A(R24)	TRANSISTOR		C111			CC73GCH1H470J	CHIP C 47PF J	
Q8			DTC363EU	DIGITAL TRANSISTOR		C112			CK73GB1H471K	CHIP C 470PF K	
Q9			RT1P144M-T111	TRANSISTOR		C113			CC73GCH1H040B	CHIP C 4.0PF B	TK-980
Q10			RT1N141U-T111	TRANSISTOR		C113			CC73GCH1H050B	CHIP C 5.0PF B	TK-981
Q11			KTA1298-P(Y)	TRANSISTOR		C114			CK73GB1H102K	CHIP C 1000PF K	TK-980
Q12			2SB1132(Q,R)	TRANSISTOR		C114			CK73GB1H471K	CHIP C 470PF K	TK-981
Q13			RT1N141U-T111	TRANSISTOR		C115			CC73GCH1H030B	CHIP C 3.0PF B	
Q15			2SC2059K(P)	TRANSISTOR		C116			CC73GCH1H060B	CHIP C 6.0PF B	
Q17			2SC4116(GR)F	TRANSISTOR		C117			CK73GB1H102K	CHIP C 1000PF K	
Q18			2SK1824-A	FET		C118			CC73GCH1HR75B	CHIP C 0.75PF B	
Q19			2SB1565(E,F)	TRANSISTOR		TC100			C05-0384-05	CERAMIC TRIMMER CAPACITOR(10P)	
Q20			RT1P441M-T111	TRANSISTOR		CN100			E40-5699-05	PIN ASSY	
Q21			RT1N441M-T111	TRANSISTOR					F10-2279-04	SHIELDING CASE	
Q22			RT1N141U-T111	TRANSISTOR				*	F12-0492-04	SHIELDING SHEET	TK-981
Q25,26			RT1P141U-T111	TRANSISTOR							
Q27			2SA1641(S,T)	TRANSISTOR							
Q28			RT1N141U-T111	TRANSISTOR							
Q30			RT1P141U-T111	TRANSISTOR							
Q31			RT1N141U-T111	TRANSISTOR							

TK-980/981

PARTS LIST

TX-RX UNIT (X57-6520-XX)

PLL/VCO UNIT (X58-4530-XX)

Ref. No.	Address	New parts	Parts No.	Description	Destination	Ref. No.	Address	New parts	Parts No.	Description	Destination
L100,101			L41-1595-33	SMALL FIXED INDUCTOR(1.5UH)							
L102		*	L41-1075-47	SMALL FIXED INDUCTOR(10NH)	TK-981						
L102		*	L41-1275-47	SMALL FIXED INDUCTOR(12NH)	TK-980						
L103			L34-4518-05	AIR-CORE COIL							
L104			L41-1098-40	SMALL FIXED INDUCTOR(1000NH)							
L105			L41-1875-47	SMALL FIXED INDUCTOR(18NH)	TK-981						
L105		*	L41-3975-47	SMALL FIXED INDUCTOR(39NH)	TK-980						
L106		*	L41-1575-47	SMALL FIXED INDUCTOR(15NH)	TK-981						
L106		*	L41-2775-47	SMALL FIXED INDUCTOR(27NH)	TK-980						
L107			L41-1595-33	SMALL FIXED INDUCTOR(1.5UH)							
R100,101			RK73GB2A000J	CHIP R 0.0 J 1/10W							
R102			RK73GB2A102J	CHIP R 1.0K J 1/10W							
R103			RK73GB2A000J	CHIP R 0.0 J 1/10W							
R104			RK73GB2A101J	CHIP R 100 J 1/10W							
R105			RK73GB2A823J	CHIP R 82K J 1/10W							
R106			RK73GB2A154J	CHIP R 150K J 1/10W							
R107			RK73GB2A270J	CHIP R 27 J 1/10W							
R108,109			RK73GB2A101J	CHIP R 100 J 1/10W							
R110			RK73GB2A221J	CHIP R 220 J 1/10W							
R111			RK73GB2A223J	CHIP R 22K J 1/10W							
R112			RK73GB2A103J	CHIP R 10K J 1/10W							
R113			RK73GB2A470J	CHIP R 47 J 1/10W							
R114			RK73GB2A000J	CHIP R 0.0 J 1/10W							
D100,101			1SV283F	VARIABLE CAPACITANCE DIODE							
D102			1SV214-F	VARIABLE CAPACITANCE DIODE							
Q100			2SC4226-A(R24)	TRANSISTOR							
Q101			2SK508NV(K52)	FET							
Q102			2SC4226-A(R24)	TRANSISTOR							

PC BOARD TK-980/981

PLL/VCO (X58-4530-XX) -10 : TK-980 -11 : TK-981
 Component side view (J79-0285-09)

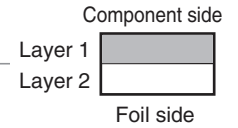
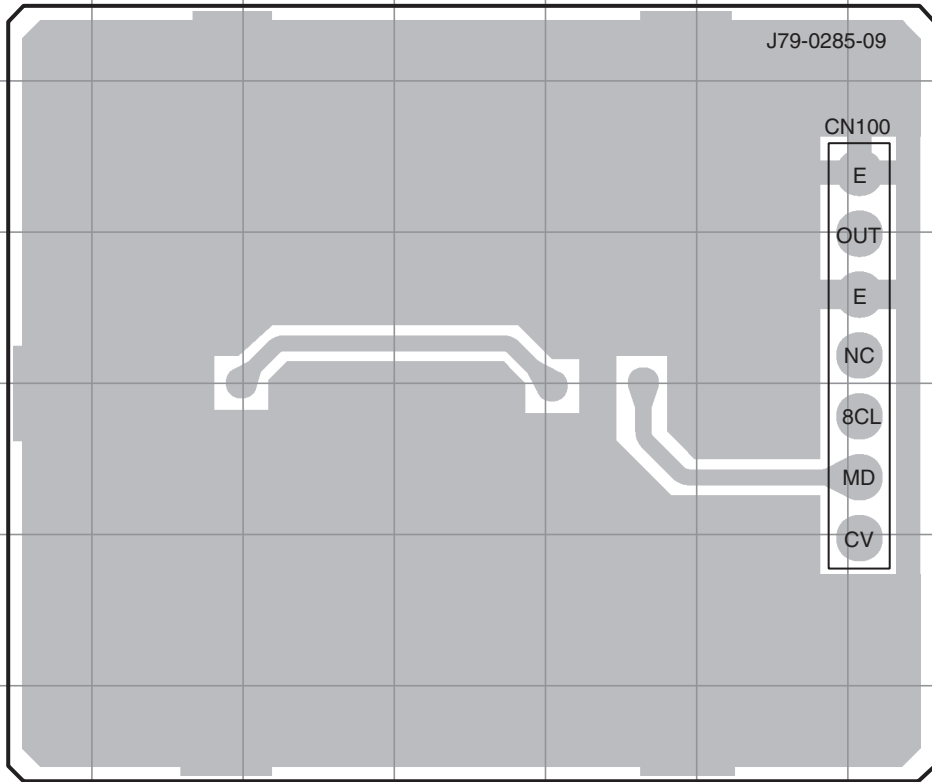

PLL/VCO (X58-4530-XX) -10 : TK-980 -11 : TK-981
 Foil side view (J79-0285-09)

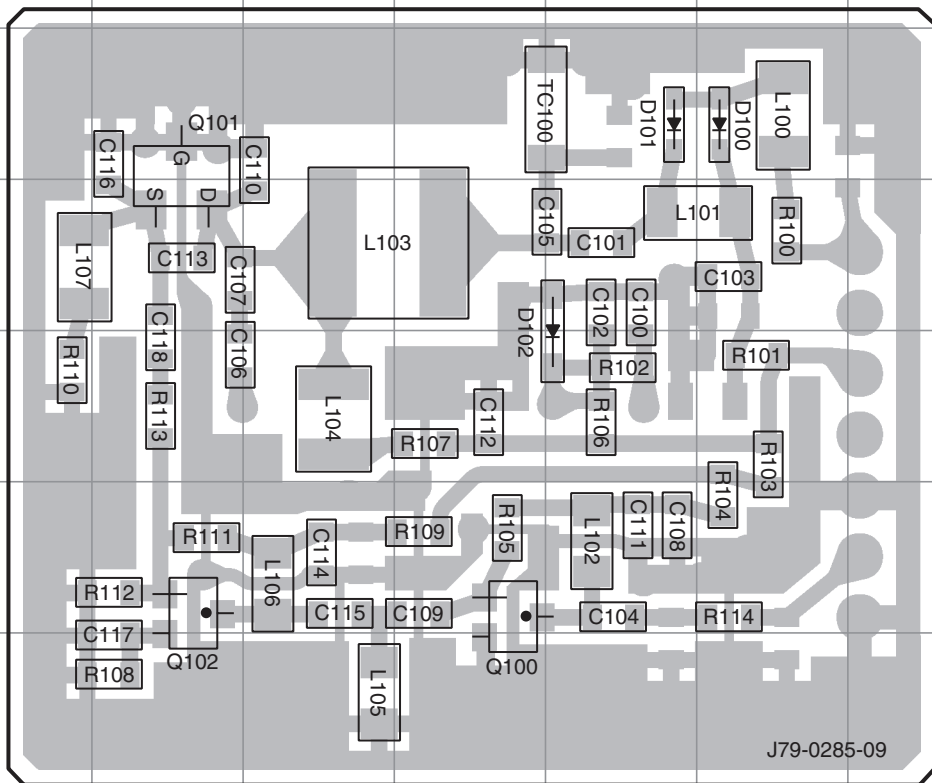

Ref. No.	Address
Q100	12E
Q101	9C
Q102	12C
D100	9G
D101	9F
D102	11F

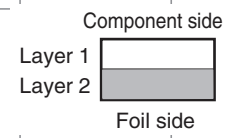

TK-980/981

PC BOARD

TX-RX UNIT : TX-RX SECTION
(X57-6520-XX) (A/2)
-10 : TK-980 -11 : TK-981
Component side view
(J79-0294-09 A/2)

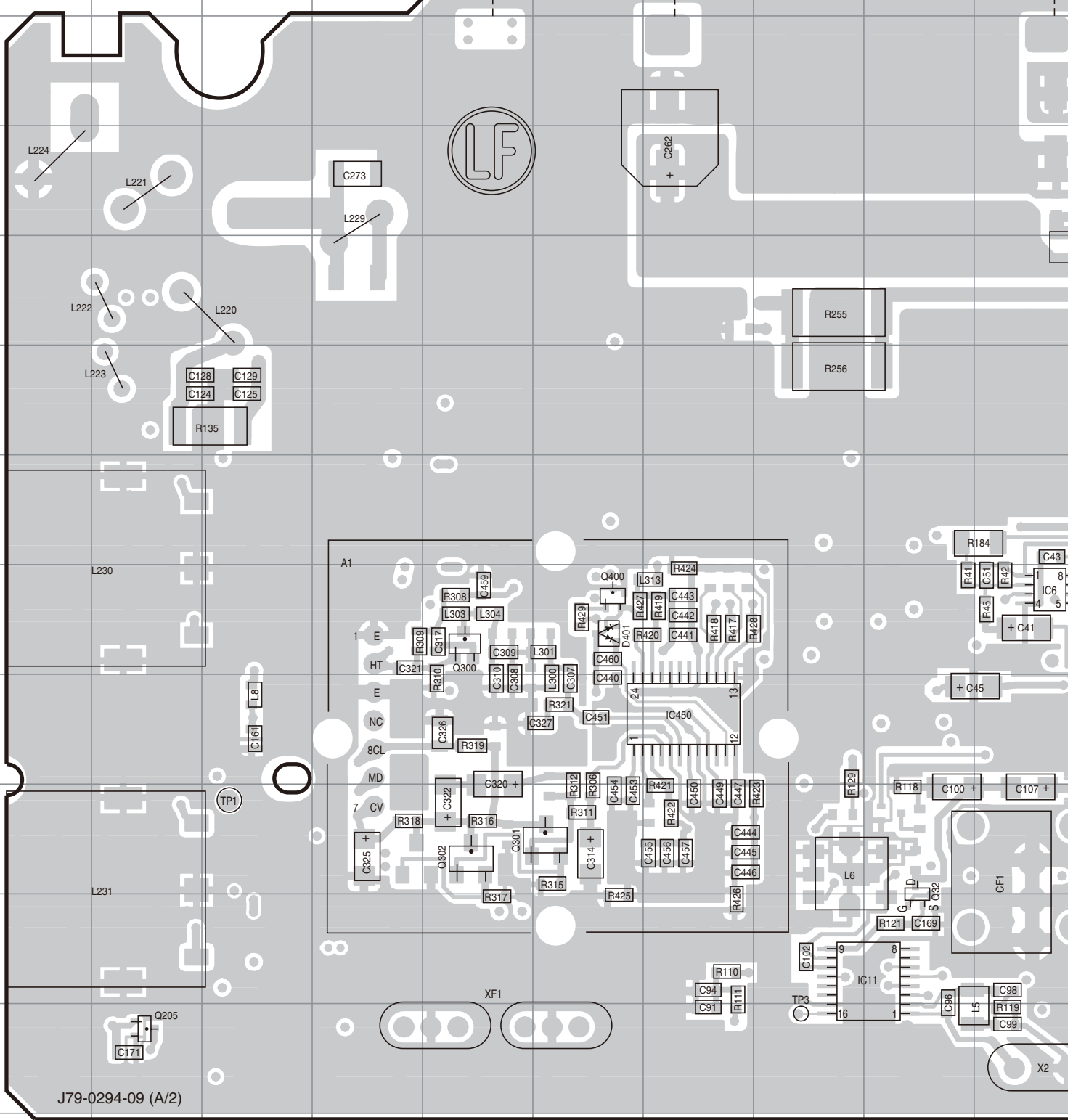

PC BOARD TK-980/981

TX-RX UNIT : TX-RX SECTION (X57-6520-XX) (A/2)
-10 : TK-980 -11 : TK-981
Component side view (J79-0294-09 A/2)

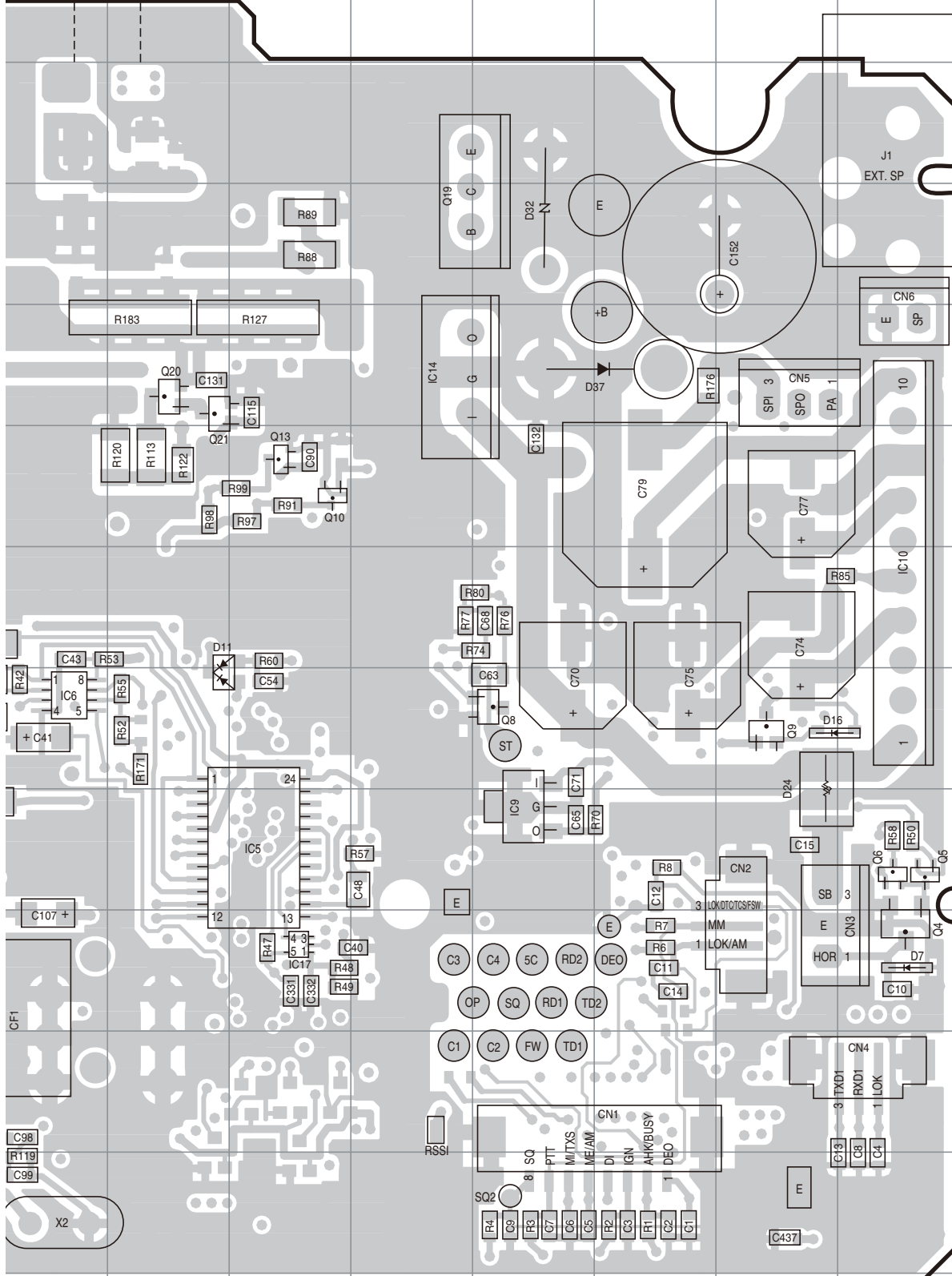

Ref. No.	Address
IC5	10L
IC6	9J
IC9	10N
IC10	8Q
IC11	12I
IC14	6M
IC17	11L
IC450	10G
Q4	11Q
Q5	10Q
Q6	10Q
Q8	9N
Q9	9P
Q10	7L
Q13	7L
Q19	5N
Q20	6K
Q21	6K
Q32	11I
Q205	13B
Q300	9E
Q301	11F
Q302	11E
Q400	9F
D7	11Q
D11	9K
D16	9Q
D24	9P
D32	5N
D37	6O
D401	9F

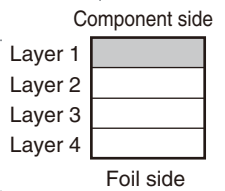

TK-980/981 PC BOARD

TX-RX UNIT : TX-RX SECTION (X57-6520-XX) (A/2)

-10 : TK-980 -11 : TK-981

Foil side view (J79-0294-09 A/2)

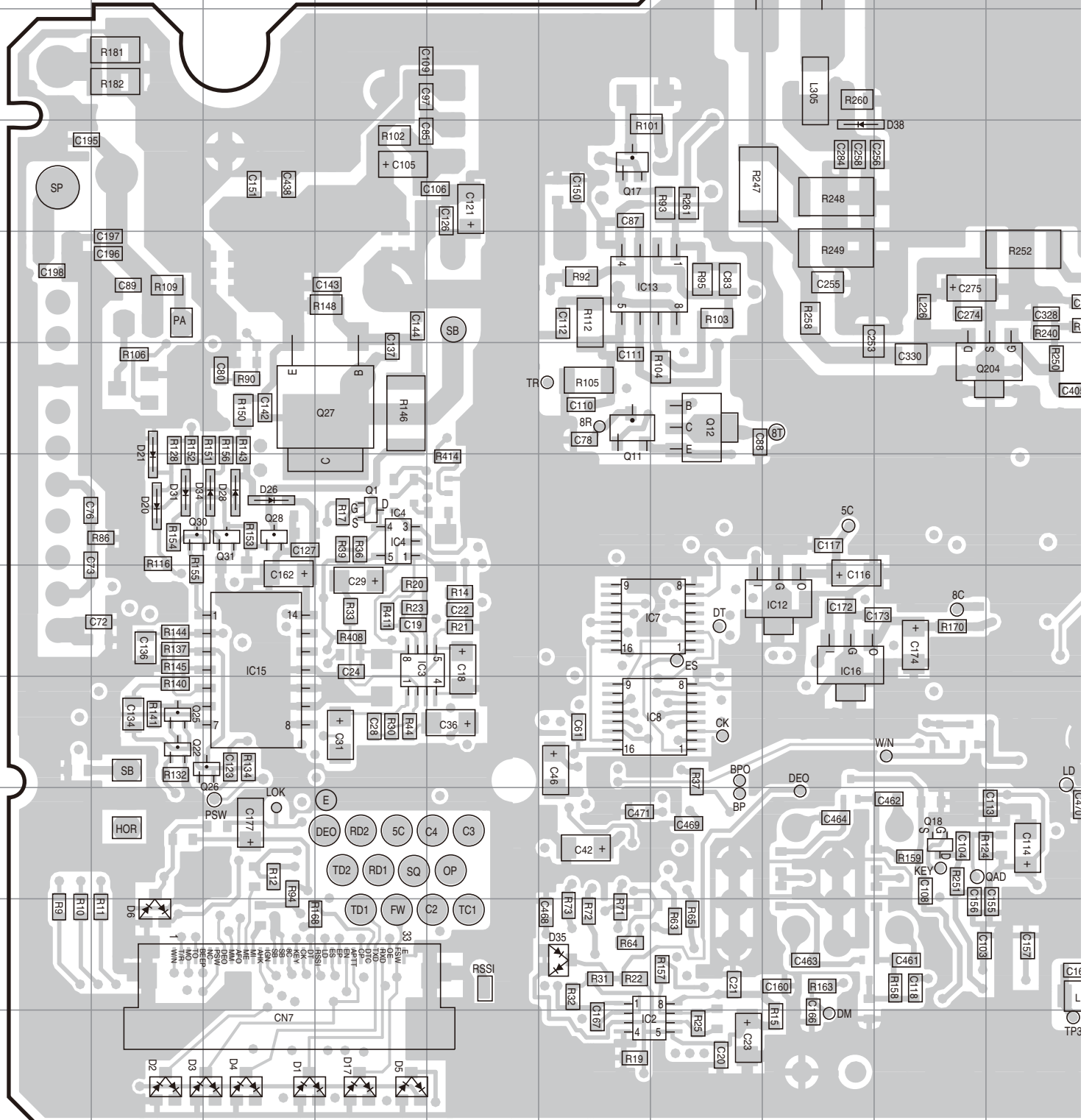

PC BOARD TK-980/981

TX-RX UNIT : TX-RX SECTION (X57-6520-XX) (A/2)

-10 : TK-980 -11 : TK-981

Foil side view (J79-0294-09 A/2)

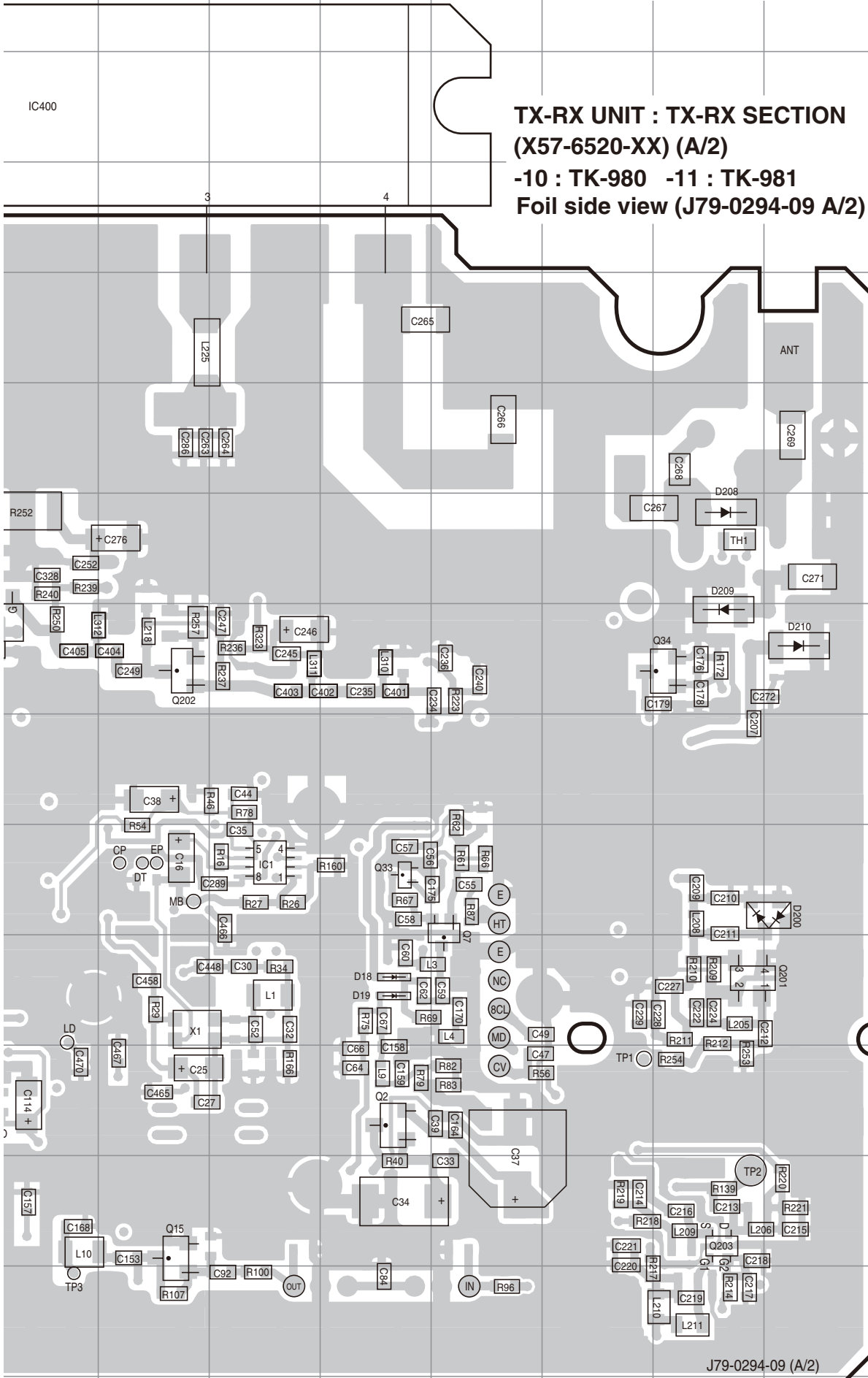

Ref. No.	Address
IC1	9L
IC2	13F
IC3	9D
IC4	8D
IC7	9G
IC8	10G
IC12	9H
IC13	6F
IC15	9C
IC16	9H
IC400	2J
Q1	8D
Q2	11M
Q7	9N
Q11	7F
Q12	7G
Q15	12K
Q17	5F
Q18	11I
Q22	10B
Q25	10B
Q26	10C
Q27	7D
Q28	8C
Q30	8B
Q31	8C
Q33	9M
Q34	7P
Q201	10P
Q202	7K
Q203	12P
Q204	7J
D1	13C
D2	13B
D3	13C
D4	13C
D5	13D
D6	12B
D17	13D
D18	10M
D19	10M
D20	8B
D21	8B
D26	8C
D28	8C
D31	8B
D34	8C
D35	12F
D38	5H
D200	9Q
D208	6P
D209	7P
D210	7Q

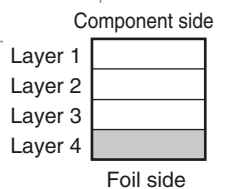

J79-0294-09 (A/2)

TK-980/981 PC BOARD

TX-RX UNIT : CONTROL SECTION (X57-6520-XX)(B/2) -10 : TK-980 -11 : TK-981

Component side view (J79-0294-09 B/2)

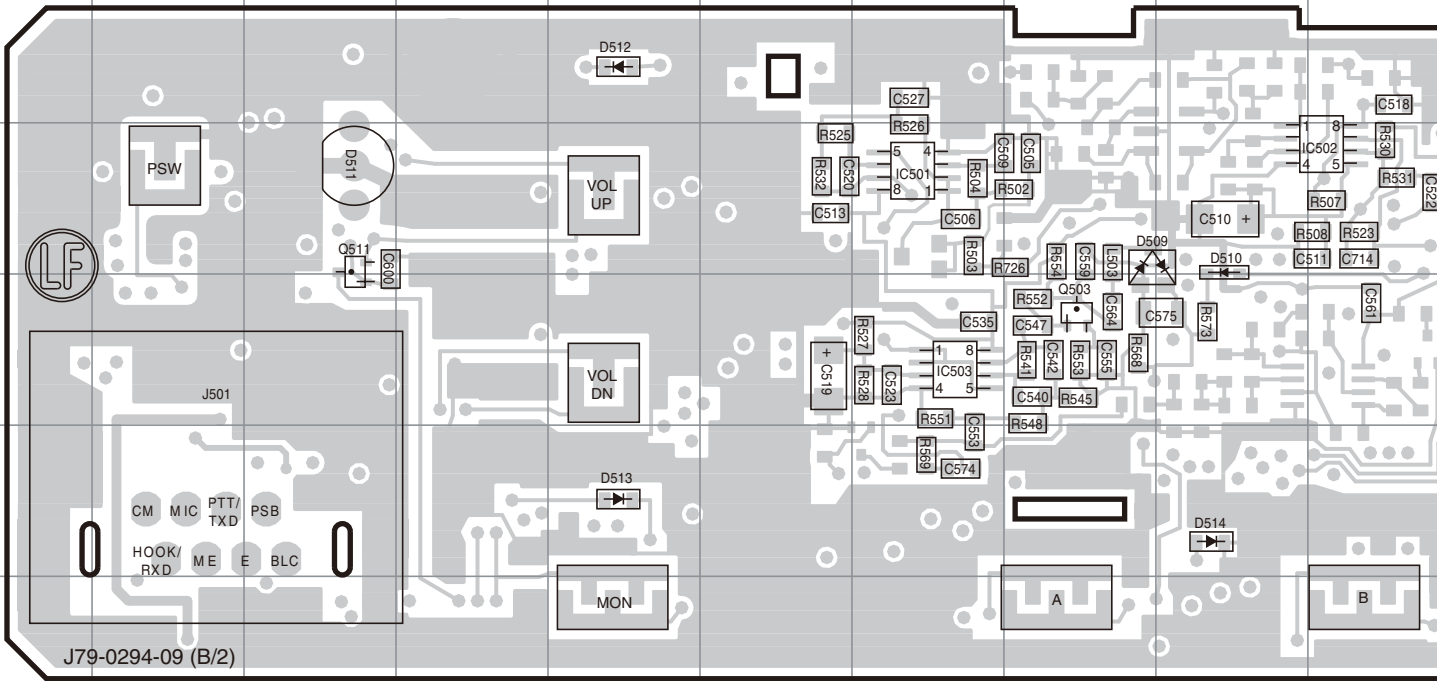

Foil side view (J79-0294-09 B/2)

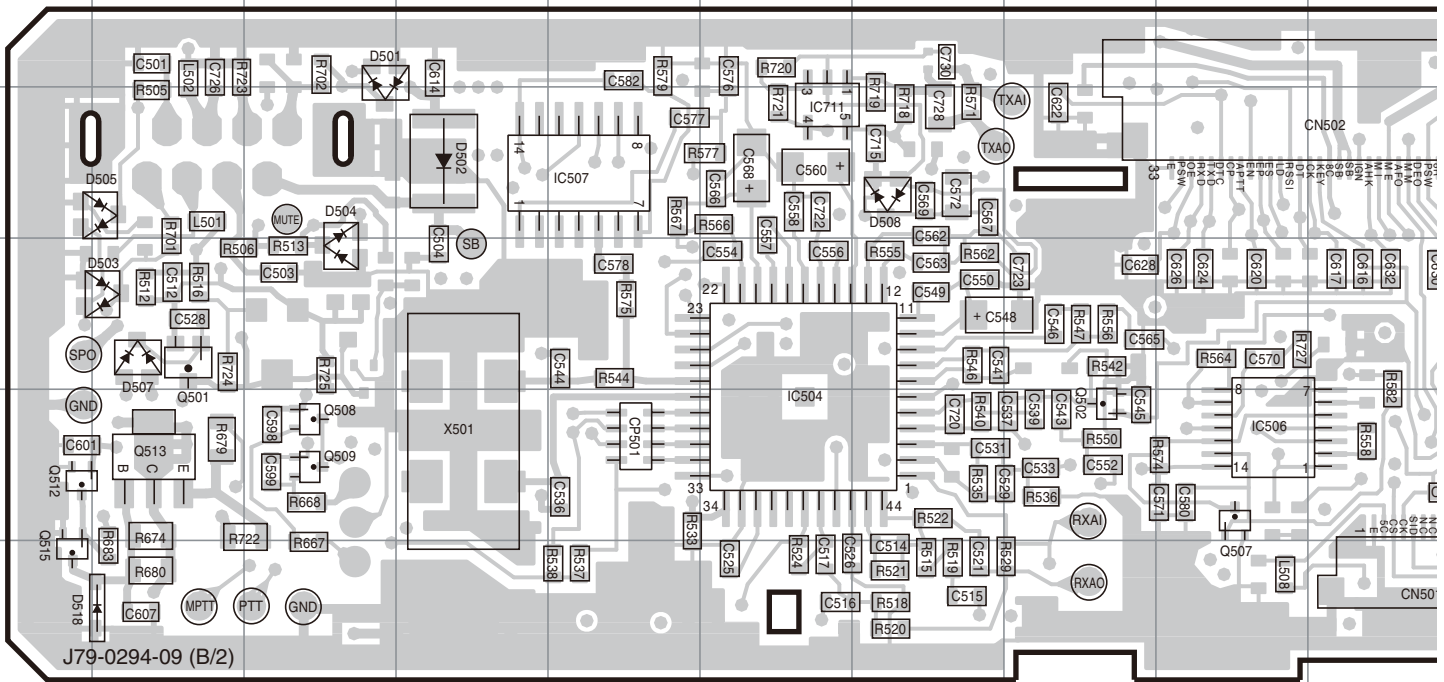

PC BOARD TK-980/981

TX-RX UNIT : CONTROL SECTION (X57-6520-XX)(B/2) -10 : TK-980 -11 : TK-981
Component side view (J79-0294-09 B/2)

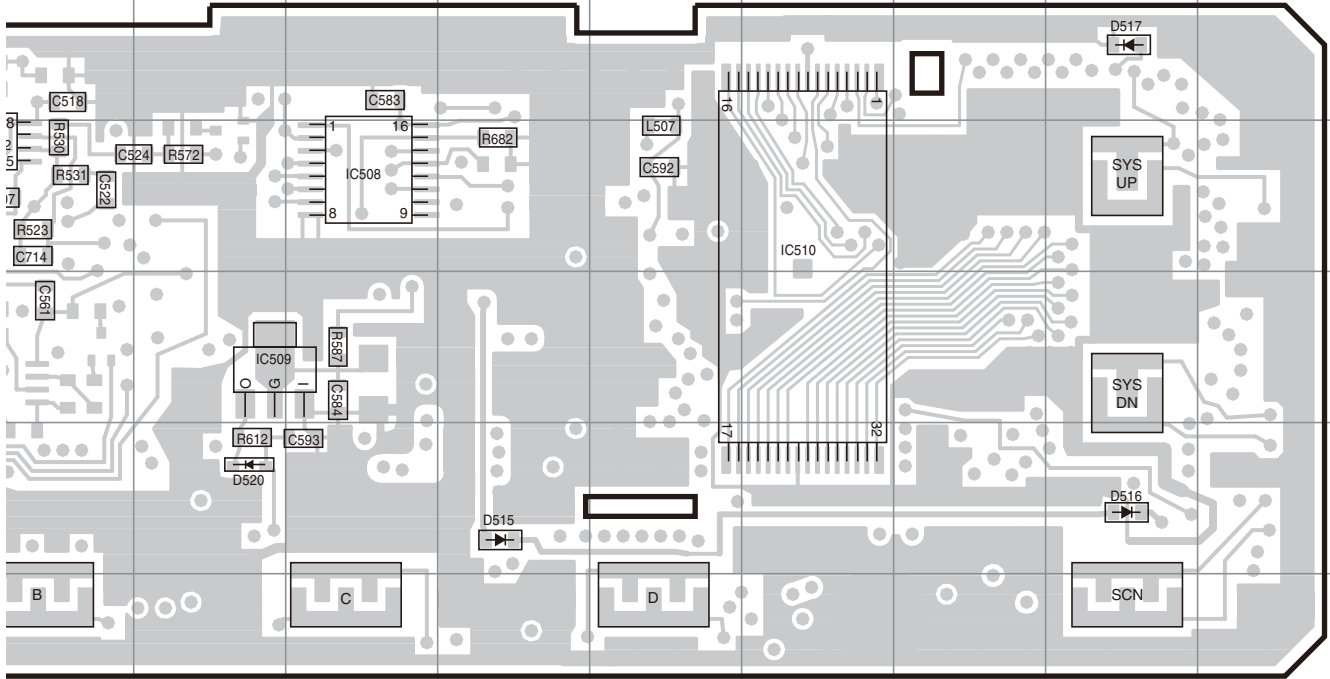

Ref No.	Address	Ref No.	Address	Ref No.	Address	Ref No.	Address
IC501	2G	IC510	3O	D511	3C	D516	5Q
IC502	3J	Q503	4H	D512	2E	D517	2Q
IC503	4G	Q511	3C	D513	5E	D520	5K
IC508	3L	D509	3H	D514	5I		
IC509	4K	D510	3I	D515	5M		

Component side

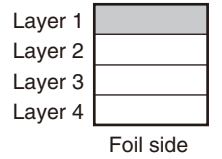

Foil side view (J79-0294-09 B/2)

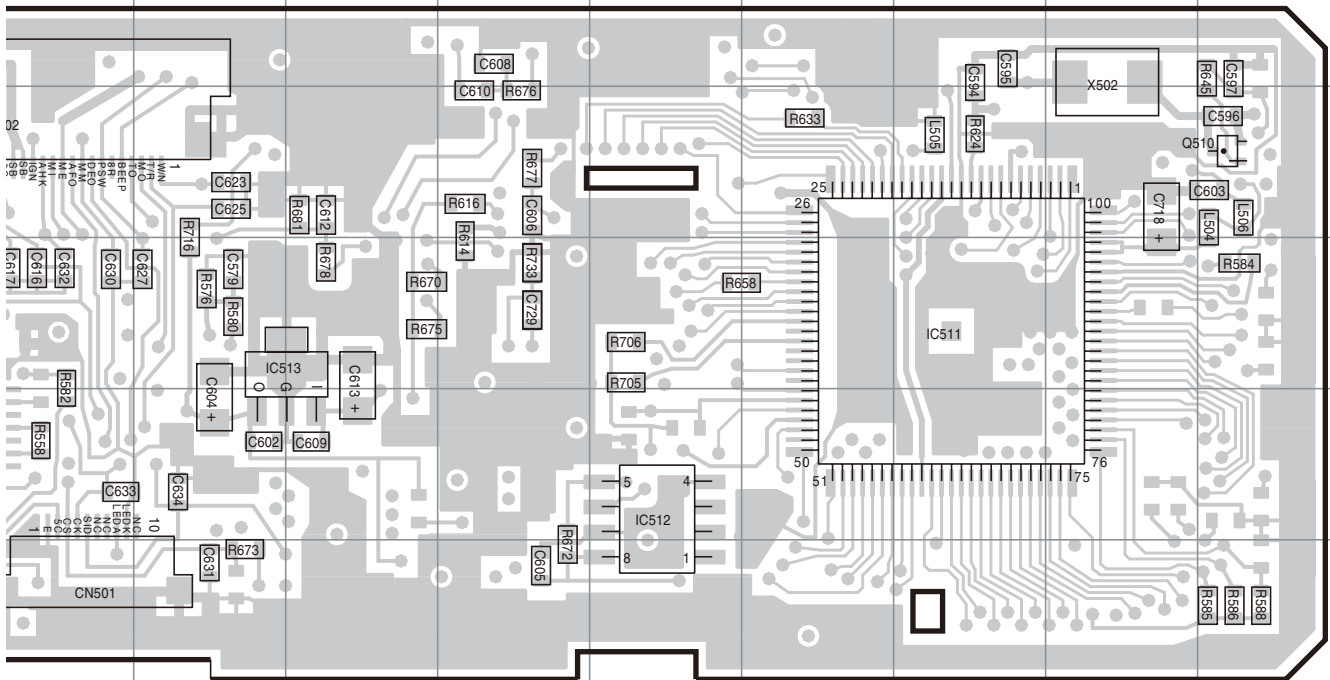

Ref No.	Address	Ref No.	Address	Ref No.	Address	Ref No.	Address	Ref No.	Address
IC504	11F	IC513	10L	Q508	11C	Q515	12A	D505	9B
IC506	11I	IC711	8F	Q509	11C	D501	8C	D507	10B
IC507	9E	Q501	10B	Q510	9R	D502	9D	D508	9G
IC511	10P	Q502	11H	Q512	11A	D503	10A	D518	12A
IC512	11N	Q507	11I	Q513	11B	D504	10C		

Component side

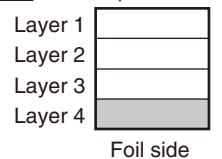

TK-980/981 SCHEMATIC DIAGRAM

TX-RX UNIT : TX-RX SECTION(X57-6520-XX) (A/2)

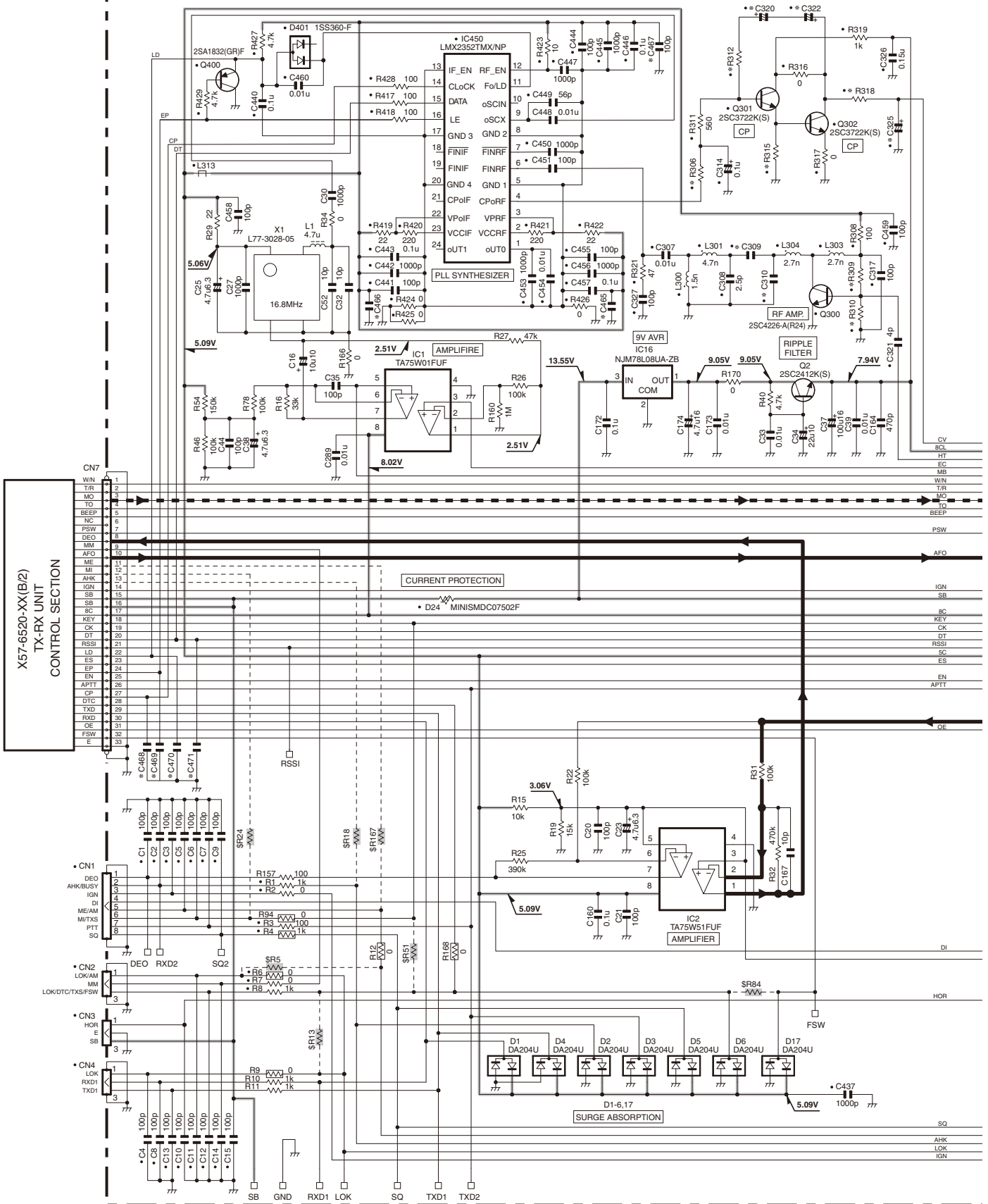

X57-6520-XX	R306	R309	R310	R312	R315	R318	C309	C310	C320	C322	C325	C465	C466	C467	C468	C469	C470	C471
0-10 TK-980	1k	33k	10k	47k	47k	390	1p	2.5p	6.8u10	6.8u10	0.68u20	100p	NO	NO	NO	NO	NO	NO
0-11 TK-981	1.8k	100k	47k	2.2k	10k	330	0.5p	1.5p	1u10	1u10	0.47u25	100p	100p	100p	100p	100p	100p	100p

SCHEMATIC DIAGRAM TK-980/981

TX-RX UNIT : TX-RX SECTION(X57-6520-XX) (A/2)

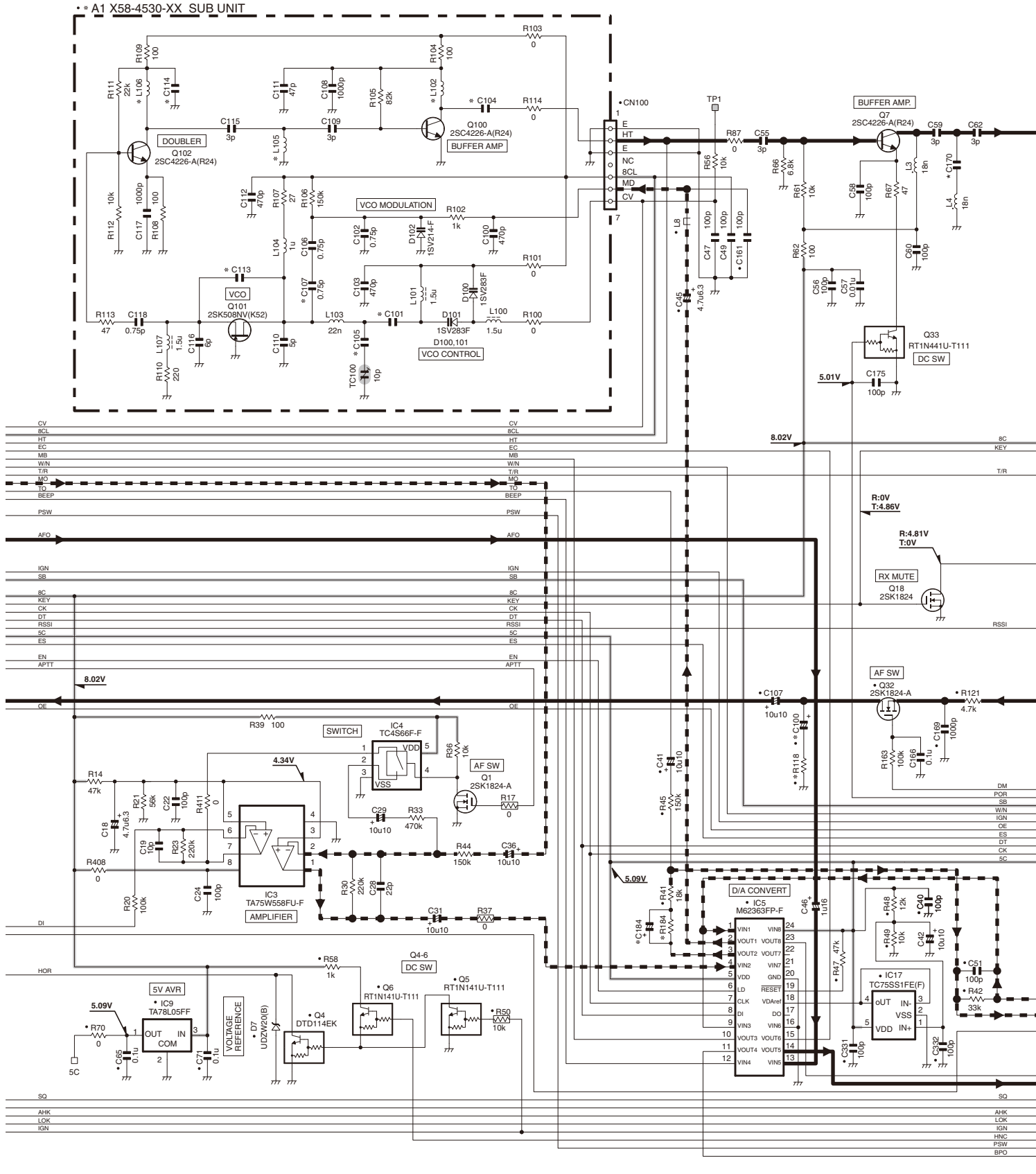

X58-4530-XX	C101	C104	C105	C107	C113	C114	L102	L105	L106
0-10 TK-980	8p	1.5p	6p	0.5p	4p	1000p	12n	39n	27n
0-11 TK-981	4.5p	1P	4p	0.75p	5p	470p	10n	18n	15n

X57-6520-XX	A1	R118	R184	C100	C170	C184
0-10 TK-980	X58-4530-10	3.9k	0	10u10	7p(B)	NO
0-11 TK-981	X58-4530-11	NO	NO	NO	5p	10u

TK-980/981 SCHEMATIC DIAGRAM

TX-RX UNIT : TX-RX SECTION(X57-6520-XX) (A/2)

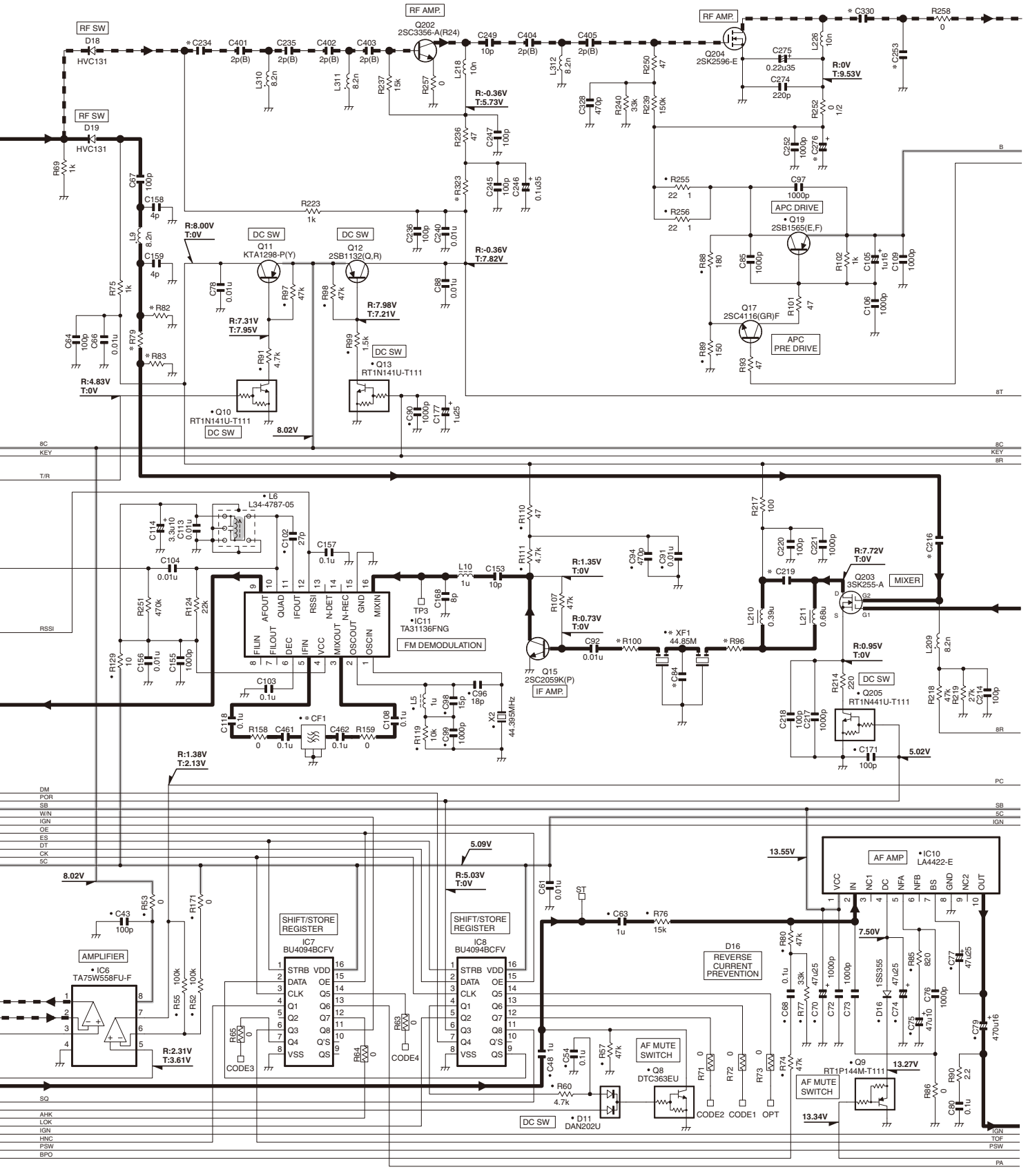

X57-6520-XX	XF1	CF1	R79	R82	R83	R96	R100	R323	C84	C216	C219	C234	C253	C276	C330	
0-10	TK-980	L71-0525-05	L72-0998-05	39	150	150	330	330	47	12p	1.5p(B)	11p	15p	6p	4.7u20	15p
0-11	TK-981	L71-0583-05	L72-0986-05	18	270	270	180	150	68	22p	1p(B)	12p	100p	8p	2.2u20	47p

SCHEMATIC DIAGRAM TK-980/981

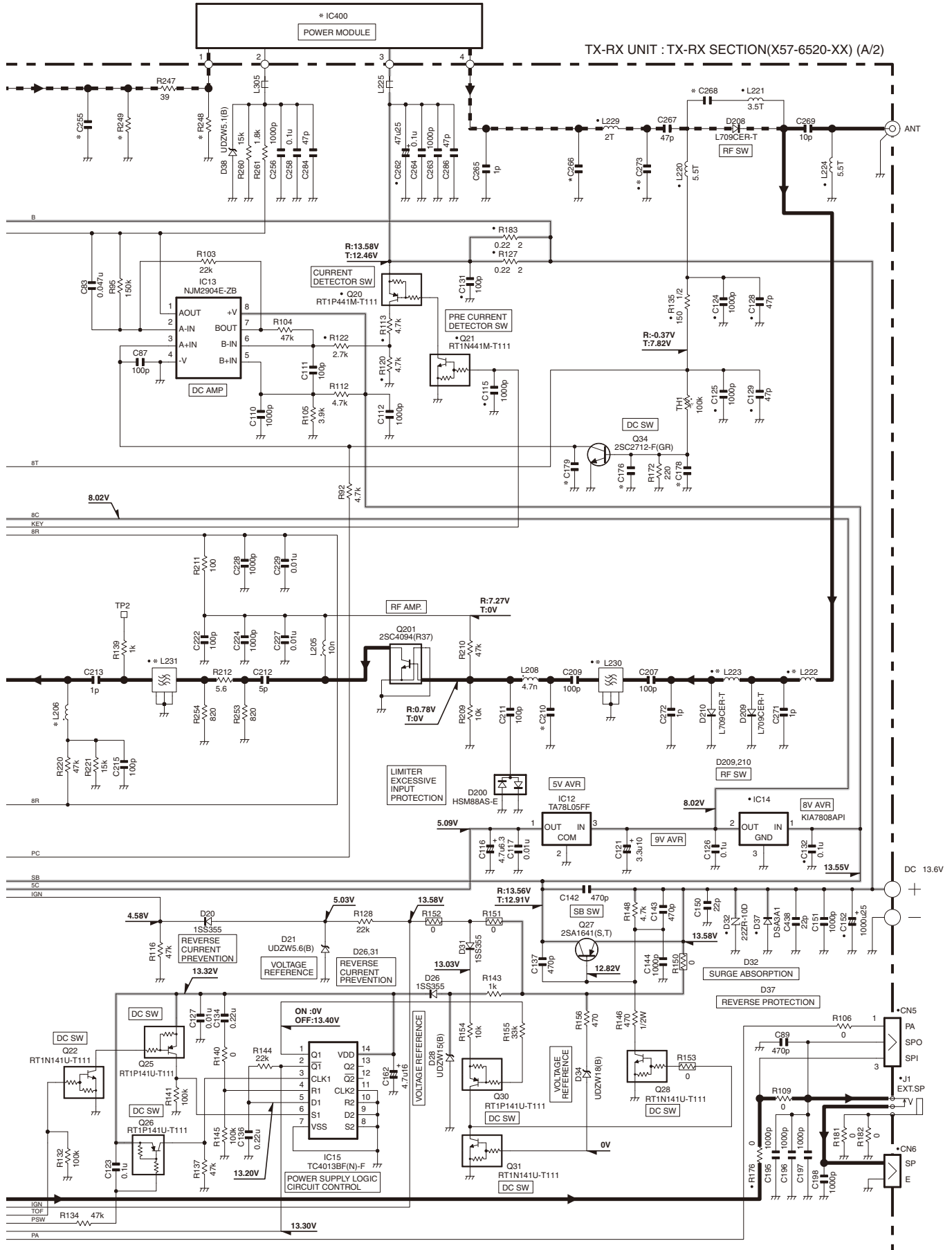

X57-6520-XX	IC400	L206	L222	L223	L230	L231	R248	R249	C176	C178	C179	C210	C255	C266	C268	C273	
0-10	TK-980	RA20H8087M	8.2n	L34-1307-05	L34-1307-05	L79-1910-05	L79-1910-05	120(1/2w)	120(1/2w)	47p	47p	NO	4p	10p	3p	47p	3p
0-11	TK-981	RA20H8994M	6.8n	L34-1313-05	L34-1313-05	L79-1911-05	L79-1911-05	150(1/2w)	150(1/2w)	100p	NO	100p	3p	4p	1p	1p	2p

Note : The components marked with a dot (•) are parts of layer 1.

TK-980/981

Kenwood Corporation

2967-3, Ishikawa-machi, Hachioji-shi, Tokyo, 192-8525 Japan

Kenwood U.S.A. Corporation

P.O. BOX 22745, 2201 East Dominguez Street, Long Beach,
CA 90801-5745, U.S.A.

Kenwood Electronics Canada Inc.

6070 Kestrel Road, Mississauga, Ontario, Canada L5T 1S8

Kenwood Electronics Deutschland GmbH

Rembrücker Str. 15, 63150 Heusenstamm, Germany

Kenwood Electronics Belgium N.V.

Leuvensesteenweg 248 J, 1800 Vilvoorde, Belgium

Kenwood Electronics France S.A.

L'Etoile Paris Nord 2, 50 Allée des Impressionnistes,
Bp 58416 Villepinte, 95944 Roissy Ch De Gaulle Cedex

Kenwood Electronics UK Limited

KENWOOD House, Dwight Road, Watford, Herts.,
WD18 9EB United Kingdom

Kenwood Electronics Europe B.V.

Amsterdamseweg 37, 1422 AC Uithoorn, The Netherlands

Kenwood Electronics Italia S.p.A.

Via G. Sirtori, 7/9 20129 Milano, Italy

Kenwood Ibérica, S.A.

Bolivia, 239-08020 Barcelona, Spain

Kenwood Electronics Australia Pty. Ltd.

Talavera Business Park Building A, 4 Talavera Road,
North Ryde NSW 2113 Australia

Kenwood Electronics (Hong Kong) Ltd.

Suite 2504, 25/F, Tower 2, Nina Tower, No. 8 Yeung Uk Road,
Tsuen Wan, New Territories, Hong Kong

Kenwood Electronics Singapore Pte Ltd

1 Ang Mo Kio Street 63, Singapore 569110

TK-980/981 PC BOARD

PC BOARD TK-980/981

**TX-RX UNIT : TX-RX SECTION
(X57-6520-XX) (A/2)**
-10 : TK-980 -11 : TK-981
**Component side view
(J79-0294-09 A/2)**

TX-RX UNIT : TX-RX SECTION (X57-6520-XX) (A/2)
-10 : TK-980 -11 : TK-981
Component side view (J79-0294-09 A/2)

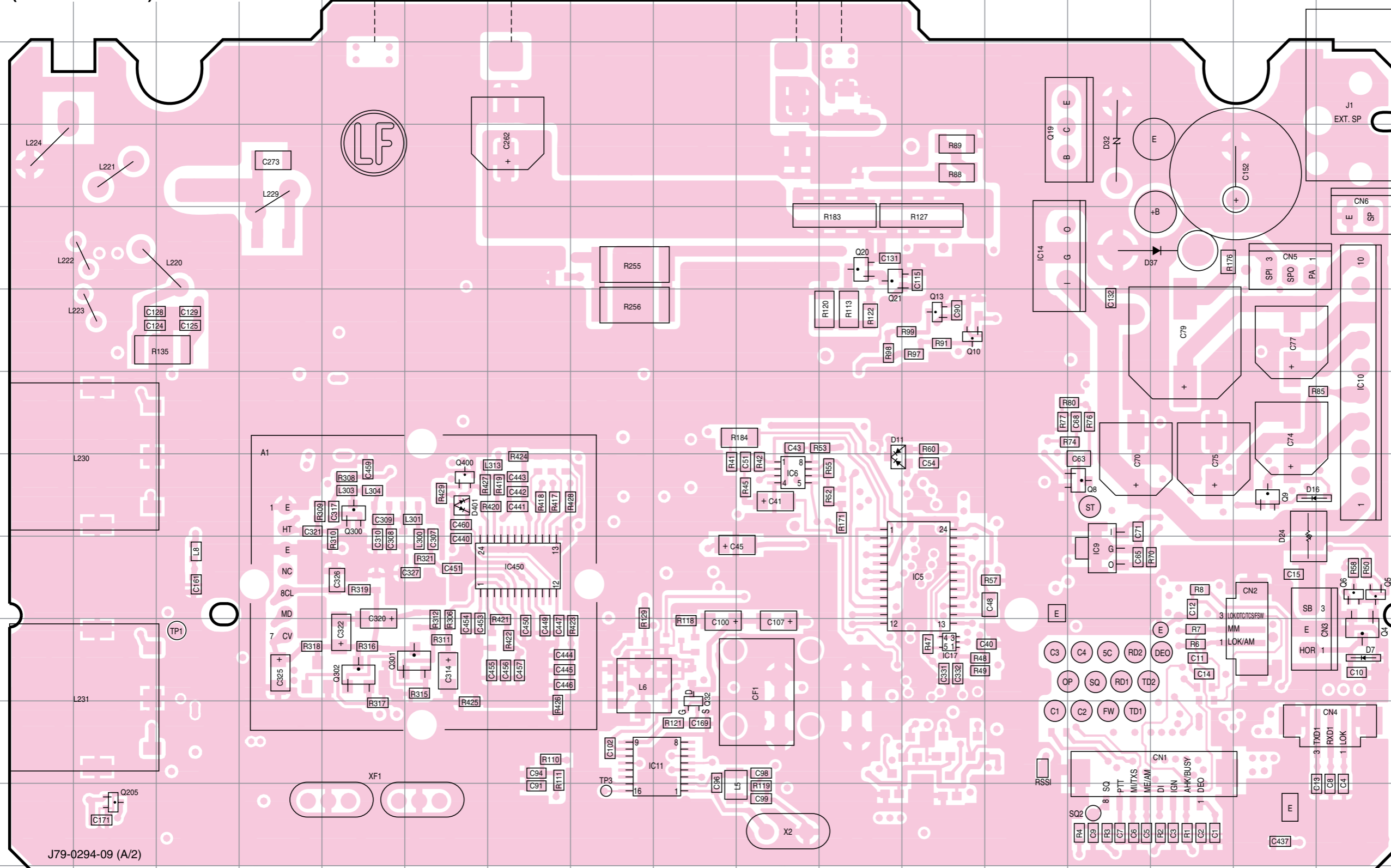

Ref. No.	Address
IC5	10L
IC6	9J
IC9	10N
IC10	8Q
IC11	12I
IC14	6M
IC17	11L
IC450	10G
Q4	11Q
Q5	10Q
Q6	10Q
Q8	9N
Q9	9P
Q10	7L
Q13	7L
Q19	5N
Q20	6K
Q21	6K
Q32	11I
Q205	13B
Q300	9E
Q301	11F
Q302	11E
Q400	9F
D7	11Q
D11	9K
D16	9Q
D24	9P
D32	5N
D37	6O
D401	9F

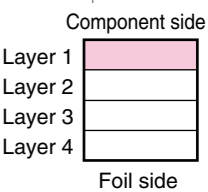

J79-0294-09 (A/2)

TK-980/981 PC BOARD

PC BOARD TK-980/981

TX-RX UNIT : TX-RX SECTION (X57-6520-XX) (A/2)

-10 : TK-980 -11 : TK-981

Foil side view (J79-0294-09 A/2)

TX-RX UNIT : TX-RX SECTION

(X57-6520-XX) (A/2)

-10 : TK-980 -11 : TK-981

Foil side view (J79-0294-09 A/2)

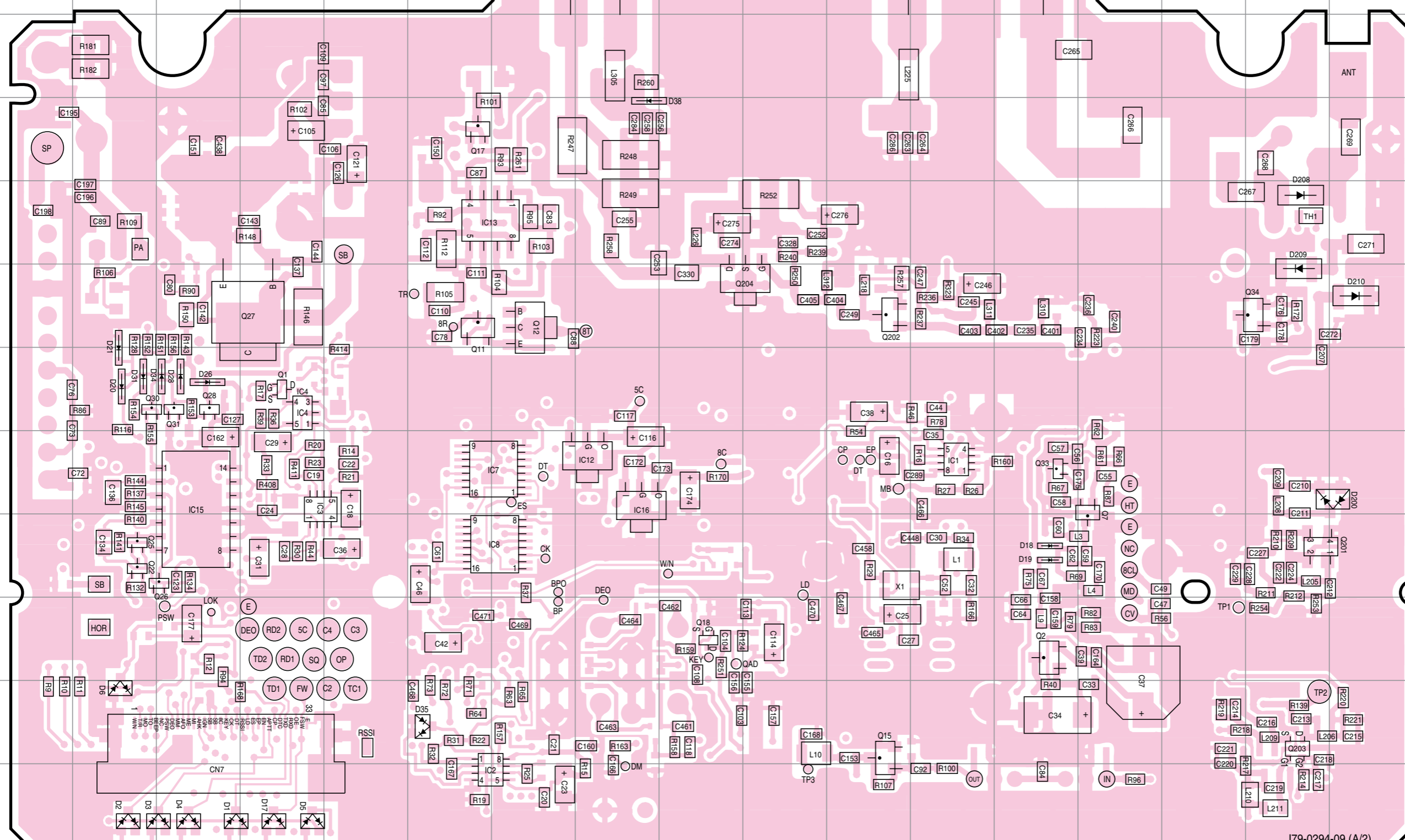

Ref. No.	Address
IC1	9L
IC2	13F
IC3	9D
IC4	8D
IC7	9G
IC8	10G
IC12	9H
IC13	6F
IC15	9C
IC16	9H
IC400	2J
Q1	8D
Q2	11M
Q7	9N
Q11	7F
Q12	7G
Q15	12K
Q17	5F
Q18	11I
Q22	10B
Q25	10B
Q26	10C
Q27	7D
Q28	8C
Q30	8B
Q31	8C
Q33	9M
Q34	7P
Q201	10P
Q202	7K
Q203	12P
Q204	7J
D1	13C
D2	13B
D3	13C
D4	13C
D5	13D
D6	12B
D17	13D
D18	10M
D19	10M
D20	8B
D21	8B
D26	8C
D28	8C
D31	8B
D34	8C
D35	12F
D38	5H
D200	9Q
D208	6P
D209	7P
D210	7Q

J79-0294-09 (A/2)

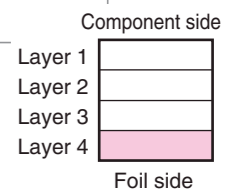

TK-980/981 PC BOARD

TX-RX UNIT : CONTROL SECTION (X57-6520-XX)(B/2) -10 : TK-980 -11 : TK-981

Component side view (J79-0294-09 B/2)

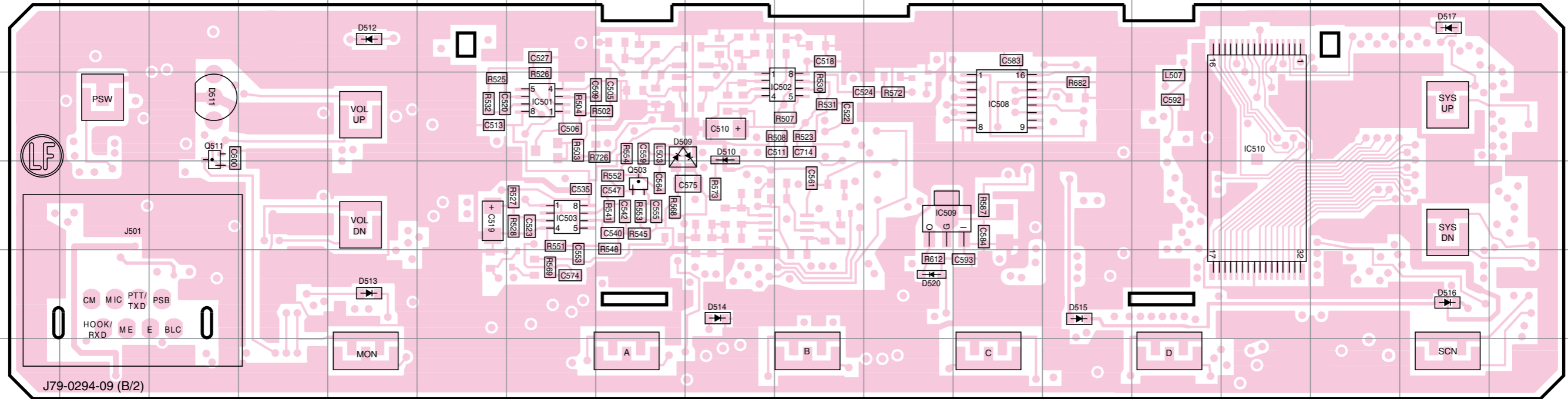

J79-0294-09 (B/2)

Ref No.	Address	Ref No.	Address	Ref No.	Address	Ref No.	Address
IC501	2G	IC510	3O	D511	3C	D516	5Q
IC502	3J	Q503	4H	D512	2E	D517	2Q
IC503	4G	Q511	3C	D513	5E	D520	5K
IC508	3L	D509	3H	D514	5I		
IC509	4K	D510	3I	D515	5M		

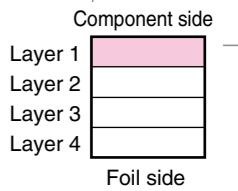

Foil side view (J79-0294-09 B/2)

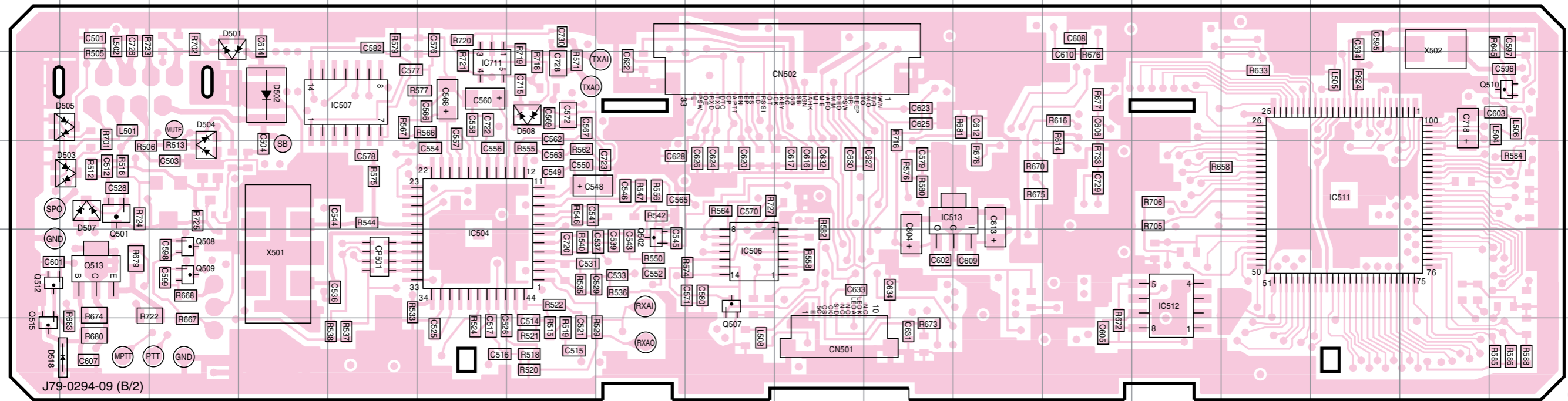

J79-0294-09 (B/2)

Ref No.	Address	Ref No.	Address	Ref No.	Address	Ref No.	Address	Ref No.	Address
IC504	11F	IC513	10L	Q508	11C	Q515	12A	D505	9B
IC506	11I	IC711	8F	Q509	11C	D501	8C	D507	10B
IC507	9E	Q501	10B	Q510	9R	D502	9D	D508	9G
IC511	10P	Q502	11H	Q512	11A	D503	10A	D518	12A
IC512	11N	Q507	11I	Q513	11B	D504	10C		

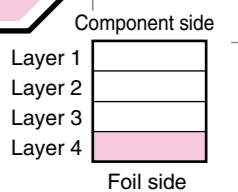

TX-RX UNIT: TX-RX SECTION(X57-6520-XX) (A/2)

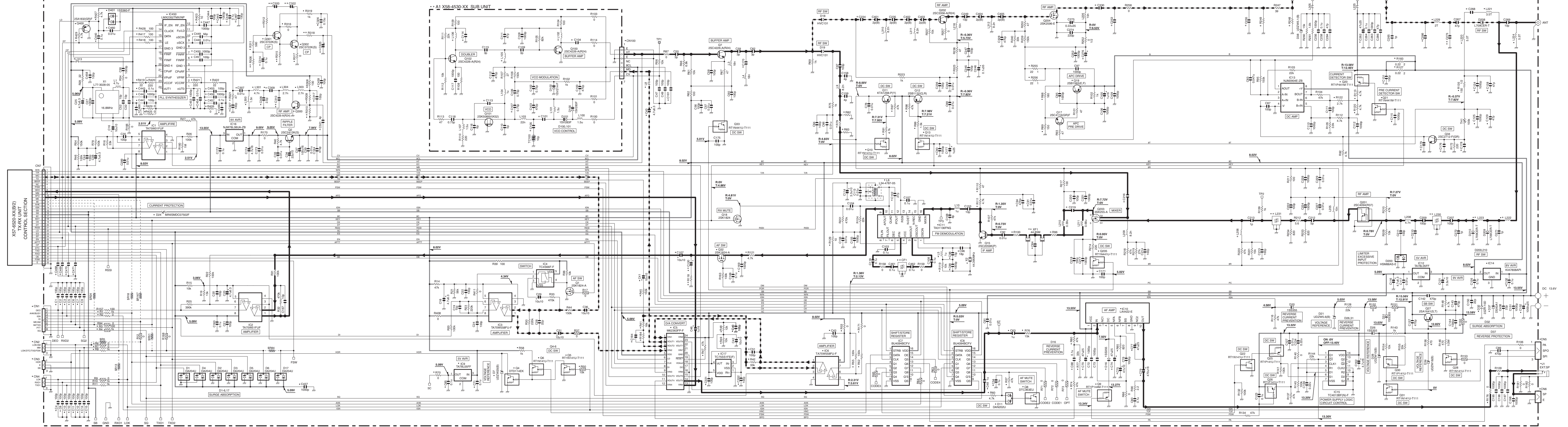

X57-6520-XX	R306	R309	R310	R312	R315	R318	C309	C310	C320	C322	C325	C465	C466	C467	C468	C469	C470	C471
0-10	TK-980	1k	33k	10k	47k	390	1p	2.5p	6.8u10	6.8u10	0.68u20	NO	NO	NO	NO	NO	NO	NO
0-11	TK-981	1.8k	100k	47k	2.2k	10k	330	0.5p	1.5p	10u10	1u10	0.47u25	100p	100p	100p	100p	100p	100p

X58-4530-XX	C101	C104	C105	C107	C113	C114	L102	L105	L106	
0-10	TK-980	8p	1.5p	6p	0.5p	4p	1000p	12h	39h	27h
0-11	TK-981	4.5p	1p	4p	0.75p	5p	470p	10h	18h	15h

X57-6520-XX	A1	R118	R184	C100	C170	C184	
0-10	TK-980	X58-4530-10	3.9k	0	10u10	7p(B)	NO
0-11	TK-981	X58-4530-11	NO	NO	NO	5p	10u

X57-6520-XX	XF1	CF1	R79	R82	R83	R100	R106	R109	R323	C84	C216	C219	C234	C253	C276	C330
0-10	TK-980	L71-0525-05	L72-0988-05	39	150	150	330	330	47	12p	1.5p(B)	11p	15p	8p	4.7u20	15p
0-11	TK-981	L71-0525-05	L72-0988-05	18	270	270	180	150	68	22p	1p(B)	12p	100p	8p	2.2u20	47p

X57-6520-XX	IC400	L206	L222	L223	L230	L231	R248	R249	C176	C178	C179	C210	C255	C266	C268	C273	
0-10	TK-980	RA20R8087M	8.2n	L34-1307-05	L34-1307-05	L79-1910-05	L79-1910-05	L201(2w)	L201(2w)	47p	47p	NO	4p	10p	3p	47p	3p
0-11	TK-981	RA20R8087M	8.8n	L34-1313-05	L34-1313-05	L79-1911-05	L79-1911-05	L501(2w)	L501(2w)	100p	NO	100p	3p	4p	1p	1p	2p